

L901

PEDESTAL TABLE. Solid lacquered ash, oak or walnut stained or oiled finish. Chrome plated steel fittings and footplate (chrome III). Chrome plated bolts. The rectangular tables have two frames. Footplates have standard diameters of 50 or 60 cm. As its name suggests, Size can be supplied in many sizes. Illustrations are for example only. Custom sizes available. Tabletop thickness 3 cm.

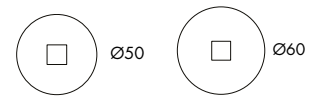

L901 (table)
 Table height 42/72
 Table top Ø50/Ø70/Ø90/Ø105/Ø120
 Area tabletop 50x50/70x70/80x80/140x70/140x80/180x80
 180x90/200x90/220x90/250x90

L901 (bar table)
 Table height 90/107
 Table top Ø50/Ø70/Ø90/Ø105
 Area tabletop 50x50/70x70/140x70/140x80/180x80
 180x90/200x80/220x80/250x80



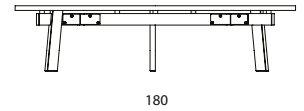
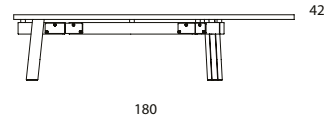
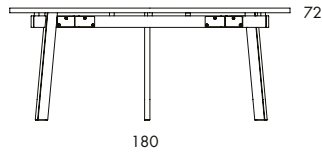
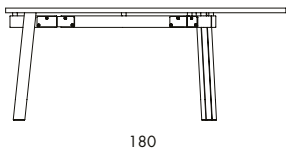
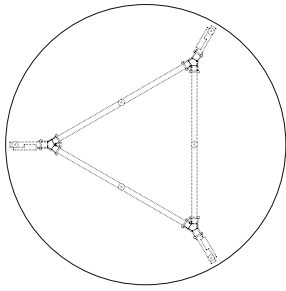

L903

TABLE WITH 3-LEGGED FRAME. For round tabletops with edging beneath the top. Solid lacquered ash, oak or walnut, stained or oiled finish. Chrome-plated steel fittings (chrome III). As its name suggests, Size can be supplied in many sizes. Illustrations are for example only. Custom sizes, materials and colours available. Tabletop thickness 3 cm

L903
 Table height 42/72
 Table top Ø140/Ø180



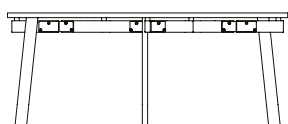
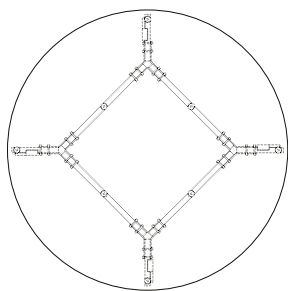

170

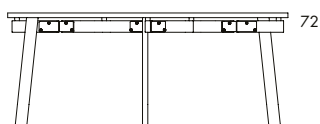

170

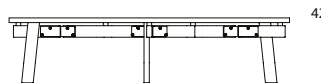

180

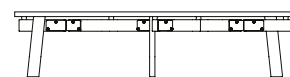

180

L904

TABLE WITH 4-LEGGED FRAME. For round or square tabletops with edging beneath the top. Solid lacquered ash, oak or walnut stained or oiled finish. Chrome-plated steel fittings (chrome III). As its name suggests, Size can be supplied in many sizes. Illustrations are for example only. Custom sizes, materials and colours available. Tabletop thickness 3 cm

L904
Table height 42
Table top Ø170/130x130

Table height 72
Table top Ø120/Ø170/130x130



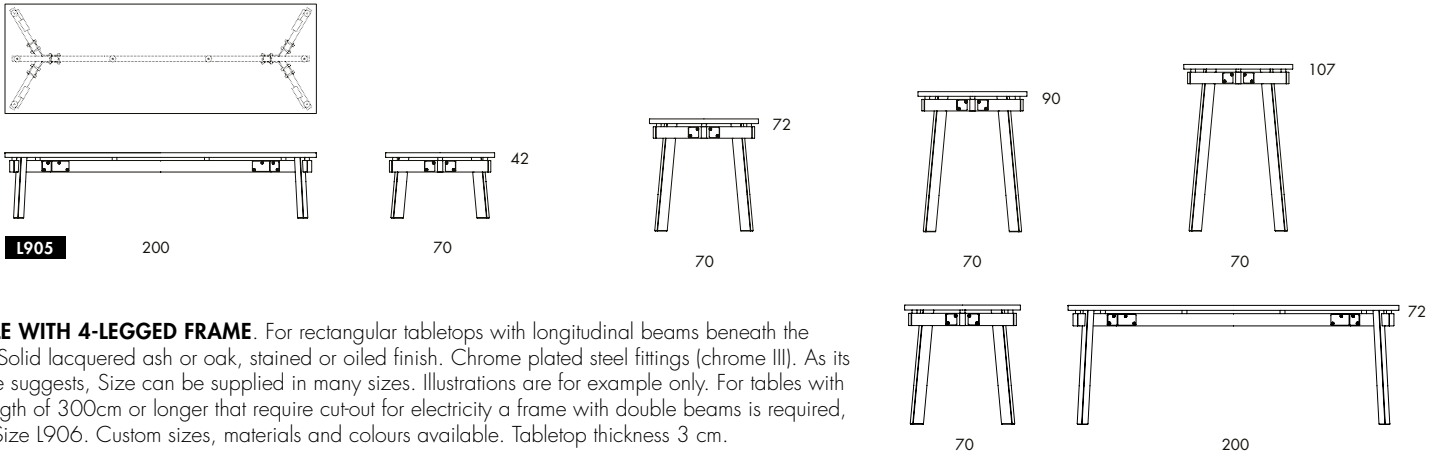

TABLE WITH 4-LEGGED FRAME. For rectangular tabletops with longitudinal beams beneath the top. Solid lacquered ash or oak, stained or oiled finish. Chrome plated steel fittings (chrome III). As its name suggests, Size can be supplied in many sizes. Illustrations are for example only. For tables with a length of 300cm or longer that require cut-out for electricity a frame with double beams is required, see Size L906. Custom sizes, materials and colours available. Tabletop thickness 3 cm.

L905 (coffee table)
 Table height 42
 Area tabletop 120x70/140x70/140x80/180x80/180x90/200x70/200x90/200x100

L905 (table)
 Table height 72
 Area tabletop 120x70/140x70/140x80/180x80/180x90/200x70/200x90/200x100
 220x90/220x100/250x90/250x100/300x90/300x100/330x90/330x100

L905 (bar table)
 Table height 90/107
 Area tabletop 120x70/140x70/140x80/180x80/180x90/200x70/200x90/200x100



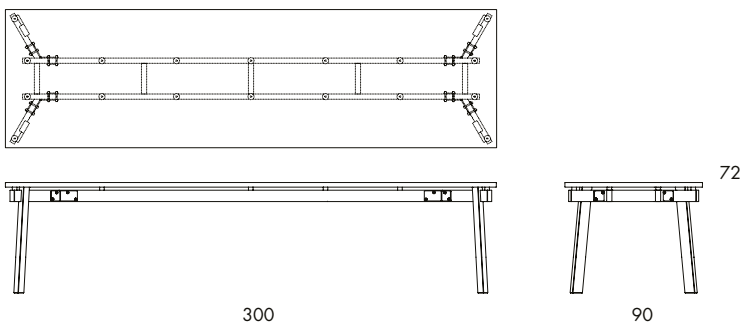

L906

TABLE WITH 4-LEGGED FRAME. For rectangular tabletops with double longitudinal beams beneath the top. Solid lacquered ash, oak or walnut, stained or oiled finish. Chrome plated steel fittings (chrome III). As its name suggests, Size can be supplied in many sizes. The Illustration is for example only. Custom sizes, materials and colours available. Tabletop thickness 3 cm

L906 (table)
 Table height 72
 Area tabletop 300x90 / 300x100 / 330x90 / 330x100

L906 (bar table)
 Table height 90
 Area tabletop 200x90



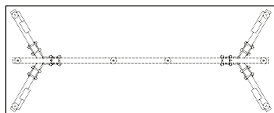

150

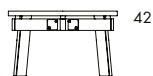

42

60

L905G

TABLE WITH 4-LEGGED FRAME Rectangular glas tabletop with a longitudinal beam beneath the top. Frame in solid lacquered ash or oak, stained or oiled finish. Chrome plated steel fittings (chrome III). Size with a glas top can be supplied in different heights and sizes on request. Tabletop in 10mm tempered glas, smokey grey colour.

	L905G (coffee table)
Table height	42
Area tabletop	150x60 / 120x50



Inspire. Create. Deliver.

P4.