

NOTES:

To achieve the best results with the assembly of our table base, we strongly recommend thread locking all screws (apply to full length of screw) and using a spanner to tighten nuts.

PARTS:









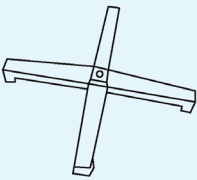

A	B	C	D	E	G	H	I	K	TOOL	TOOL
				 FOLDING MECH.	 HEX HEAD 8MM	 17MM NUT	 WASHER	 FOOT GLIDE	 THREAD LOCK	 SPANNER
X1	X1	X1	X1	X1	X1	X4	X2	X4	NOT INCLUDED	NOT INCLUDED

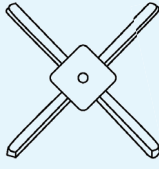
DIAGRAM:

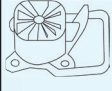

NOTES:

To achieve the best results with the assembly of our table base, we strongly recommend thread locking all screws (apply to full length of screw) and using a spanner to tighten nuts.

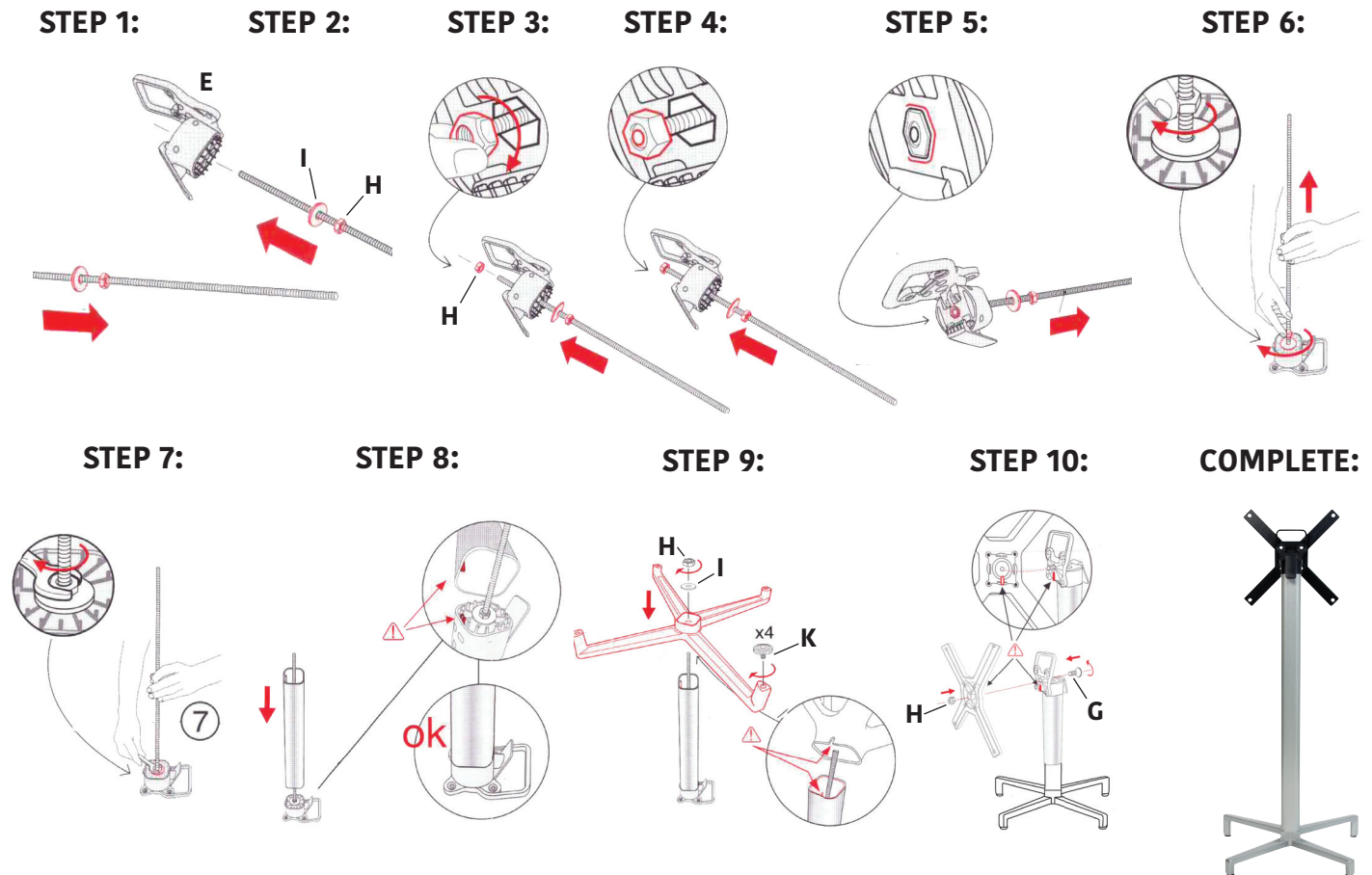
PARTS:







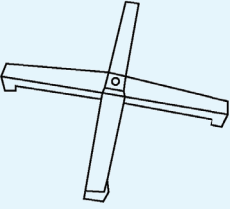

A	B	C	D	E	F	G	TOOL	TOOL
								
X1	X1	X1	X1	X3	X2	X4	NOT INCLUDED	NOT INCLUDED

DIAGRAM:

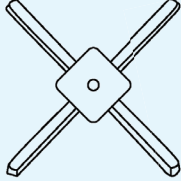
STEP 1:



STEP 2:

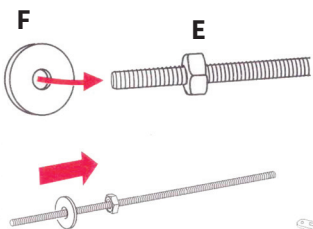
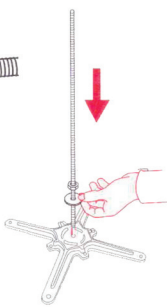

STEP 3:

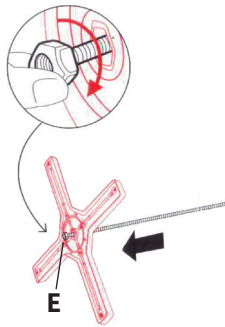

STEP 4:

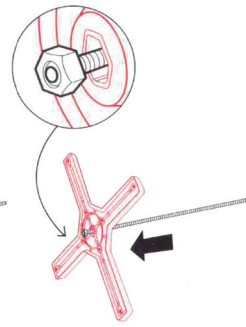

STEP 5:

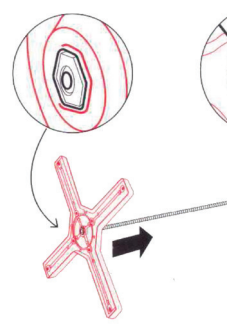

STEP 6:

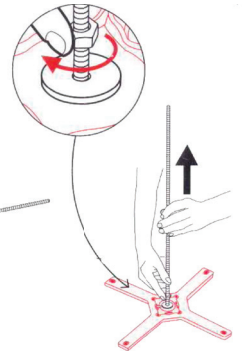

STEP 7:

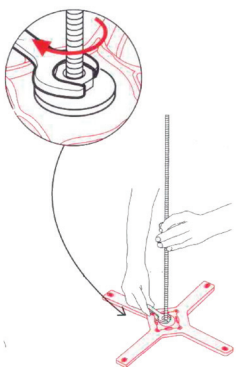

STEP 8:

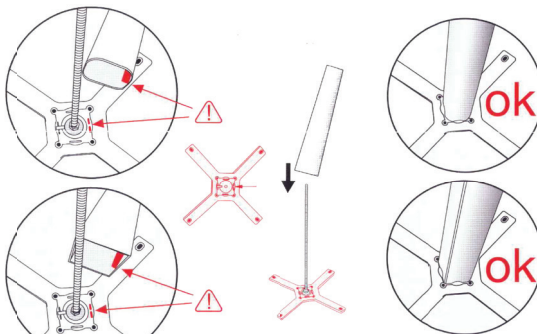

STEP 9:

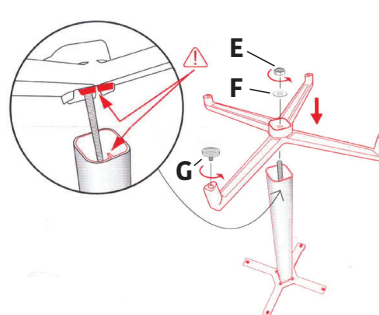

COMPLETE:



Inspire | Create | Deliver

P4.