

# ABISKO

Claesson Koivisto Rune

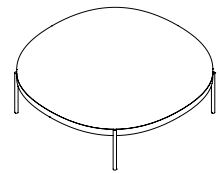
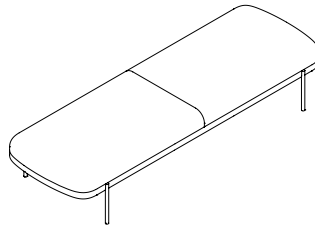
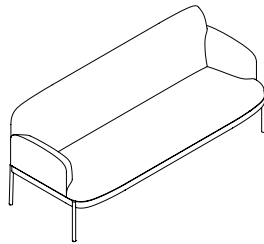
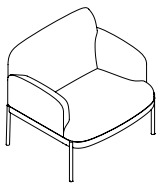

**ARMCHAIR**  
POLTRONA - FAUTEUIL

**2 SEATER SOFA**  
DIVANO - CANAPÉ

**BENCH**  
PANCA - BANC

**ROUND BENCH**  
PANCA CIRCOLARE - BANC CIRCOLAIRE

## COLORS AND MATERIALS

COLORI E MATERIALI - COULEURS ET MATÉRIAUX

### WOOD LEGNO - BOIS



oakwood  
rovere  
chêne

The standard finish is beechwood.  
Customized RAL colors are available upon request.

La finitura standard è il faggio.  
Colori RAL personalizzati sono disponibili su richiesta.

La finition standard est le hêtre.  
Sur demande, d'autres couleurs spéciales sont disponibles en RAL.

### STEEL FEET PIEDI IN ACCIAIO - PIEDS EN ACIER



Click on the icons to see the standard RAL finishings for the steel bases on the dedicated page. Customized RAL colors finishings are available upon request.

Clicca sulle icone per vedere le finiture RAL standard delle basi in acciaio sulla pagina dedicata. Su richiesta sono disponibili colorazioni customizzate su altre tinte RAL.

Cliquez sur les icônes pour voir les finitions RAL standard des bases en acier sur la page dédiée. Des couleurs RAL personnalisées sont disponibles sur demande.

## TECHNICAL FEATURES

SPECIFICHE TECNICHE - SPÉCIFICATIONS TECHNIQUES

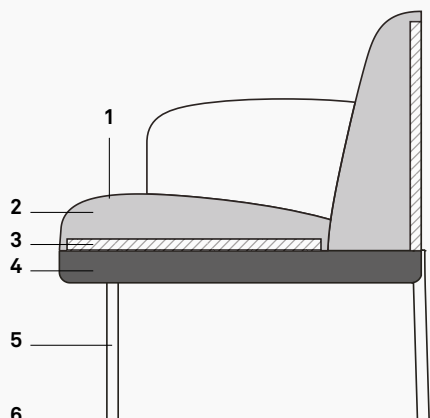

### 1. Upholstery

Rivestimento  
Revetement

### 2. High resistance foam

Poliuretano espanso indeformabile  
Mousse haute densité

### 3. Wooden inner frame

Struttura interna in legno  
Structure interne en bois

### 4. Solid oakwood frame edge

Struttura esterna in rovere massello  
Structure extérieure en chêne massif

### 5. Steel tube legs

Gambe in tubo d'acciaio  
Pieds en tube d'acier

### 6. Felt pad

Feltrino  
Freutre

Internal structure in multilayer wood, polyurethane foam padding; external structure in solid oakwood and frame with 4 varnished steel legs.

Struttura interna in multistrato, imbottitura in poliuretano espanso; struttura esterna in rovere massello e telaio con 4 gambe in acciaio verniciato.

Structure interne en contreplaqué, rembourrage en mousse polyuréthane; structure extérieure en chêne massif et structure à 4 pieds en acier peint.

## COFFEE TABLE VARIANTS

VARIANTI TAVOLINO - VARIANTES DE TABLE BASSE

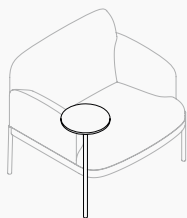

### Available for the two front legs

Disponibile per le due gambe anteriori  
Disponibile pour les deux pieds avant

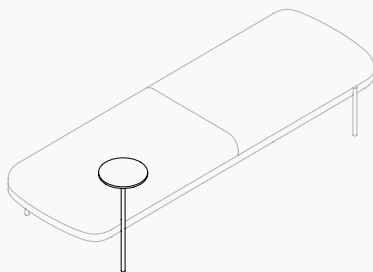

### Available for all legs

Disponibile per tutte le gambe  
Disponibile pour tout le pieds

**AB 1000**  
armchair  
poltrona  
fauteuil

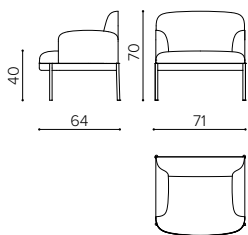

# m 2,15    ☆ mq 4    📦 kg 18,5    🛠 mc 0,3

**AB 2000**  
2 seater sofa  
divano 2 posti  
canapé 2 places

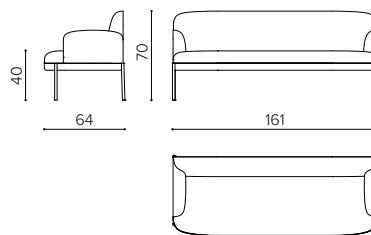

# m 3,6    ☆ mq 6,6    📦 kg 36    🛠 mc 0,7

**AB 5P0R**  
pouf  
pouf  
pouf

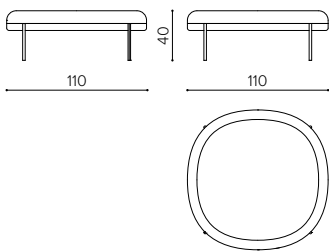

# m 2,4    ☆ mq 4    📦 kg 20    🛠 mc 0,4

**AB 3P00**  
bench  
panca  
banc

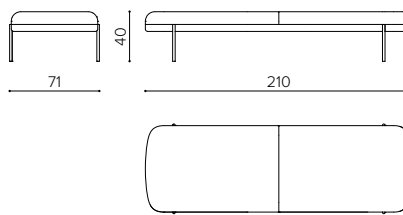

# m 2,4    ☆ mq 4    📦 kg 30    🛠 mc 0,59

**AB T25R**  
coffee table  
tavolino  
table basse

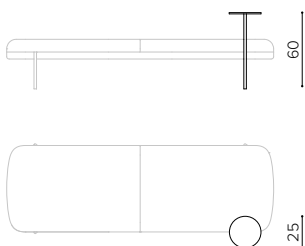

# UPHOLSTERY CATEGORIES

CATEGORIE RIVESTIMENTI - CATÉGORIES DE TISSUS D'AMEUBLEMENT

S

**camira**

GRAVITY

76% Polyester, 24% Recycled Polyester, non metallic dyestuffs

76% Poliestere, 24% Poliestere riciclato, coloranti non metallici

76% Polyester, 24% Polyester recyclé, colorants non métalliques

100% Polyester Trevira CS

100% Poliestere Trevira CS - 100% Polyester Trevira CS

FIDIVI

LASER N

T

FIDIVI

MAYA

100% Polyester Trevira CS

100% Poliestere Trevira CS - 100% Polyester Trevira CS

FIDIVI

INCAS

100% Polyester Trevira CS

100% Poliestere Trevira CS - 100% Polyester Trevira CS

FIDIVI

LASER J & J FLASH

100% Polyester Trevira CS

100% Poliestere Trevira CS - 100% Polyester Trevira CS

M

**kvadrat**

FIELD 2

100% Polyester Trevira CS

100% Poliestere Trevira CS - 100% Polyester Trevira CS

FIDIVI

CLASS

100% Polyester Trevira CS

100% Poliestere Trevira CS - 100% Polyester Trevira CS

**camira**

MAIN LINE FLAX

70% Virgin Wool, 30% Flax

70% Lana Vergine, 30% Lino - 70% Laine vierge, 30% Lin

**SPRADLING®**

VALENCIA

Vinyl / Urethane Topcoat

Finitura in vinile / uretano - Revêtement de finition vinyle / uréthane

F

**camira**

BLAZER

100% Virgin Wool, non metallic dyestuffs

100% Lana Vergine, coloranti non metallici - 100% Laine vierge, colorants non métalliques

**camira**

SYNERGY

95% Virgin Wool, 5% Polyamide

95% Lana Vergine, 5% Poliammide - 95% Laine vierge, 5% Polyamide

**kvadrat**

REMIX 2

90% New wool (worsted), 10% Nylon

90% Lana vergine (pettinata), 10% Nylon - 90% Laine vierge (peignée), 10% Nylon

L

**kvadrat**

MERIT

97% New wool (worsted), 3% Nylon

97% Lana vergine (pettinata), 3% Nylon - 97% Laine vierge (peignée), 3% Nylon

P

**kvadrat**

FIORD

92% New wool (worsted), 8% Nylon

92% Lana vergine (pettinata), 8% Nylon - 92% Laine vierge (peignée), 8% Nylon

**kvadrat**

DIVINA 3

100% New wool

100% Lana vergine - 100% Laine vierge

**kvadrat**

DIVINA MD

100% New wool

100% Lana vergine - 100% Laine vierge

GENUINE LEATHER

European bovine leather

Pelle bovina europea - Cuir de bovin européen

PX

FULL GRAIN  
GENUINE LEATHER

European bovine leather, full grain

Pelle pieno fiore, bovina europea - Cuir de bovin européen, pleine fleur

# STANDARD STEEL RAL COLORS

COLORI RAL STANDARD PER ACCIAIO - COULEURS RAL STANDARD POUR L'ACIER

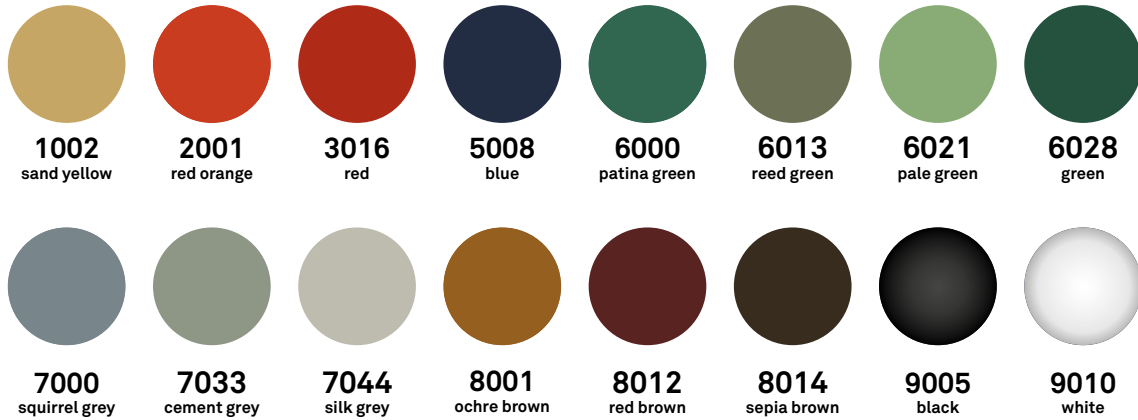

The standard finishings for the steel elements are the RAL shown.  
Customized RAL colors finishings are available upon request.

Le finiture standard degli elementi in acciaio sono i RAL mostrati.  
Su richiesta sono disponibili colorazioni customizzate su altre tinte RAL.

Les finitions standard des éléments en acier sont le RAL illustré.  
Des couleurs RAL personnalisées sont disponibles sur demande.



## COLOR SWATCHES AND TECH INFO

CAMPIONI COLORI E INFO TECNICHE - ÉCHANTILLONS DE COULEURS ET INFOS TECHNIQUES

### DOWNLOAD

Click on the image above to download the color swatches  
and technical informations

Clicca sull'immagine per scaricare il pdf dei campioni colori  
e specifiche tecniche

Cliquez sur l'image ci-dessus pour télécharger les échantillons  
de couleurs et les informations techniques



Inspire | Create | Deliver

P4.