

ALADDIN

Leonardo Rossano

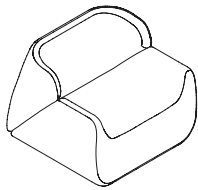

ARMCHAIR

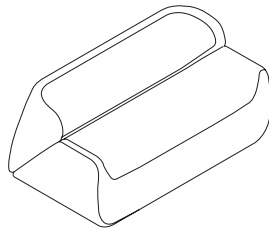

2 SEATER SOFA

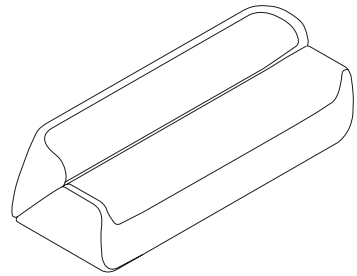

3 SEATER SOFA

TECHNICAL FEATURES

SPECIFICHE TECNICHE - SPÉCIFICATIONS TECHNIQUES

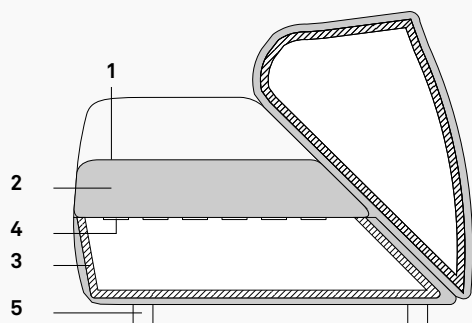

1. Upholstery

Rivestimento
Revetement

2. High resistance foam

Poliuretano espanso indeformabile
Mousse haute densité

3. Wooden inner frame

Struttura interna in legno
Structure interne en bois

4. Elastic straps

Cinghie elastiche
Bandes élastiques

5. Polypropylene feet

Piedini in polipropilene
Pieds en polypropilène

Inner wooden frame, seat with elastic bands, variable density flexible foam padding. Polypropylene feet.

Fusto in legno, seduta con cinghie elastiche; imbottitura in poliuretano espanso a densità differenziate. Piedini in polipropilene.

Structure interne en bois, assise avec bandes élastiques, rembourrée avec mousse à densité différenciée. Pieds en polypropilène.

AL 1000

armchair

poltrona

fauteuil 1 place

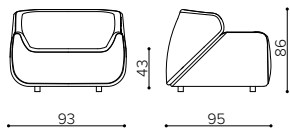

m 5,3 ⬡ mq 7,9 🛒 kg 30 📏 mc 0,5

AL 2000

2 seater sofa

divano 2 posti

canapé 2 places

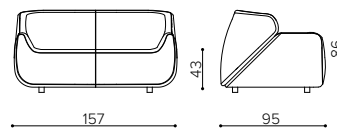

m 7 ⬡ mq 10,2 🛒 kg 40 📏 mc 1,3

AL 3000

3 seater sofa

divano 3 posti

canapé 3 places

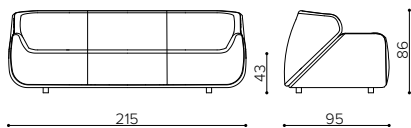

m 9,7 ⬡ mq 14 🛒 kg 55 📏 mc 1,75

Inspire | Create | Deliver

P4.