

Eighty
Favaretto & Partners



P4.



The Eighty, designed for the contract environment, is a collection of coffee tables defined by large shapes and sinuous lines, evoking the curvy style predominant in the 80s.

The 80 mm diameter of the aluminium tube chosen by Studio Favaretto and Partners as the base for each table is also distinctive: with its robust structure, Eighty is an iconic object.







EIGHTY

Favaretto & Partners



EIGHTY EG THR7
table Ø700mm

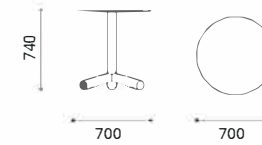

white hpl
total black hpl
black fenix
hpl decorated wood

EIGHTY EG TLR7
table Ø700mm

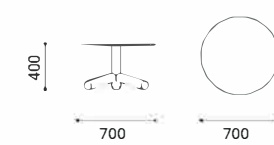

white hpl
total black hpl
black fenix
hpl decorated wood

EIGHTY EG THR8
table Ø800mm

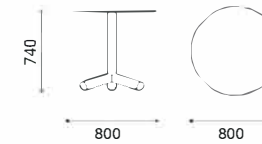

white hpl
total black hpl
black fenix
hpl decorated wood

EIGHTY EG TLR8
table Ø800mm

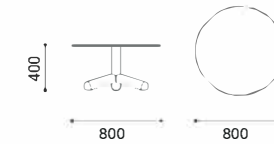

white hpl
total black hpl
black fenix
hpl decorated wood

TECHNICAL FEATURES

80mm tubular section base, 3mm thick,
4mm thick flat support plate, hpl or fenix top

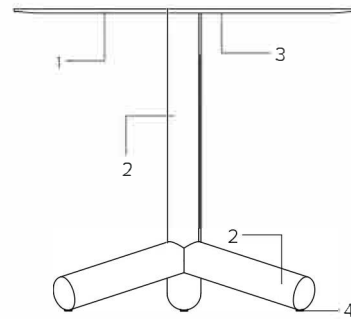

- 1 Top
- 2 Tubular base 80mm thick
- 3 Steel support plate
- 4 Rubber feet

EIGHTY EG THR9
table Ø900mm

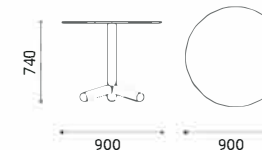

white hpl
total black hpl
black fenix
hpl decorated wood

EIGHTY EG TLR9
table Ø900mm

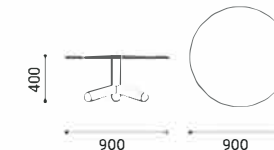

white hpl
total black hpl
black fenix
hpl decorated wood

COLOURS AND MATERIALS

To view the full range of P4 colours and materials for this product, please refer to www.p4.design

EIGHTY EG TBR7
table Ø700mm

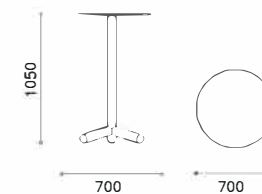

white hpl
total black hpl
black fenix
hpl decorated wood

Inspire. Create. Deliver.