

# STONE

Baldanzi & Novelli Design

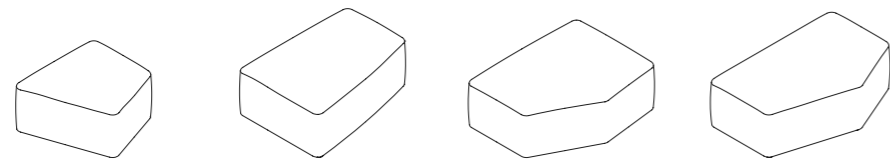

MODULE A

MODULE B

MODULE C

MODULE D

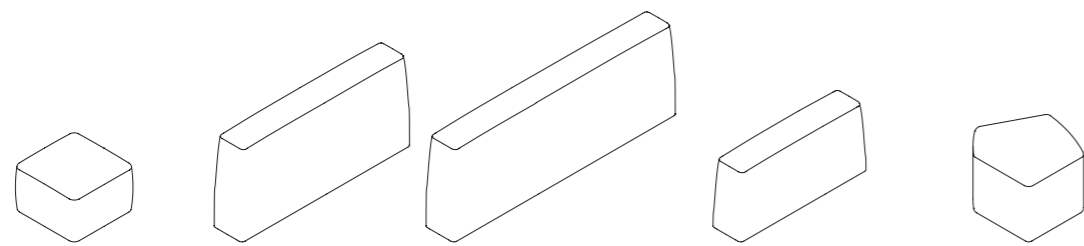

MODULE E

MODULE F

MODULE G

MODULE H

MODULE POUF

## TECHNICAL FEATURES

SPECIFICHE TECNICHE - SPÉCIFICATIONS TECHNIQUES

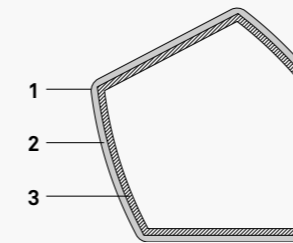

### 1. Upholstery

Rivestimento  
Revêtement

### 2. High resistance foam

Poliuretano espanso indeformabile  
Mousse haute densité

### 3. Wooden inner frame

Struttura interna in legno  
Structure interne en bois

## SIDE VIEW

VISTA LATERALE - VUE LATÉRALE

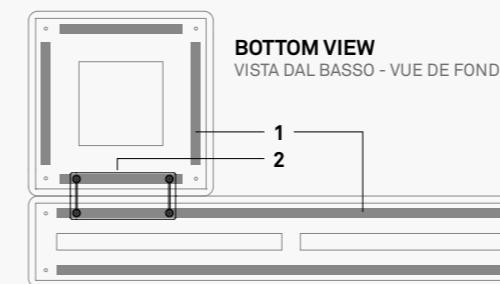
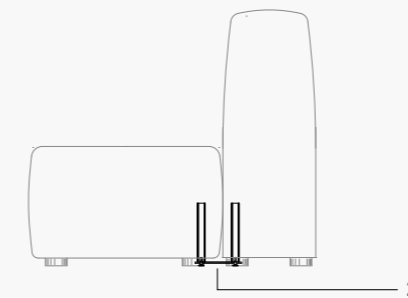

Multilayer beechwood inner structure, high density foam padding. Polypropylene feet.

## JUNCTION DETAILS

DETTAGLIO AGGANCIAMENTO - DÉTAILS DE LA JONCTION

### 1. Junction channels

Corsia di aggancio  
Canaux de jonction

### 2. Junction element

Elemento di aggancio  
Élément de connexion

Struttura interna in multistrato di faggio, imbottitura in poliuretano espanso indeformabile. Piedini in polipropilene.

Structure intérieure en hêtre multicouche, rembourrage en mousse haute densité. Pieds en polypropylène.

**ST A00R**  
right module A  
modulo A destro  
module A droit

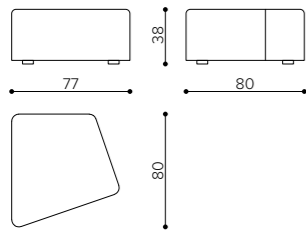

# m 1,7 ☼ mq 3,4 📦 kg 16 🛠 mc 0,26

**ST A00L**  
left module A  
modulo A sinistro  
module A gauche

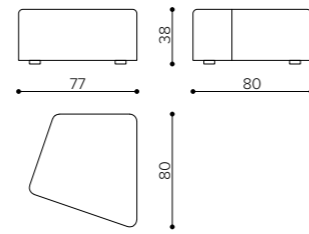

# m 1,7 ☼ mq 3,4 📦 kg 16 🛠 mc 0,26

**ST D00R**  
right module D  
modulo D destro  
module D droit

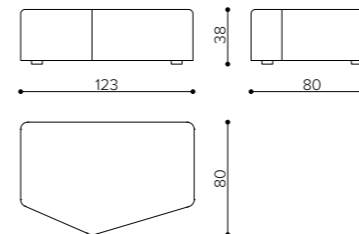

# m 2,8 ☼ mq 5,6 📦 kg 25 🛠 mc 0,4

**ST D00L**  
left module D  
modulo D sinistro  
module D gauche

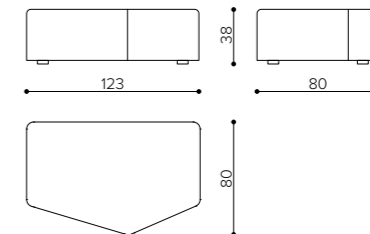

# m 2,8 ☼ mq 5,6 📦 kg 25 🛠 mc 0,4

**ST B00R**  
right module B  
modulo B destro  
module B droit

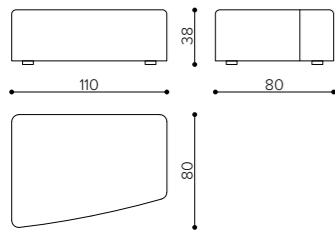

# m 2,35 ☼ mq 4,7 📦 kg 24 🛠 mc 0,36

**ST B00L**  
left module B  
modulo B sinistro  
module B gauche

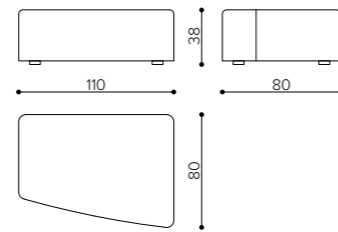

# m 2,35 ☼ mq 4,7 📦 kg 24 🛠 mc 0,36

**ST E000**  
square pouf, module E  
pouf quadrato, modulo E  
pouf carré, module E

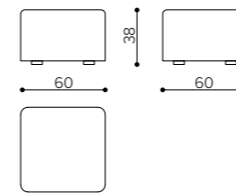

# m 1,35 ☼ mq 2,7 📦 kg 14 🛠 mc 0,15

**ST F000**  
backrest, module F  
schienale, modulo F  
dossier, module F

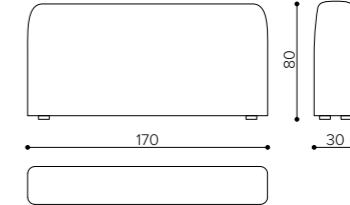

# m 3,55 ☼ mq 7 📦 kg 35 🛠 mc 0,45

**ST C00R**  
right module C  
modulo C destro  
module C droit

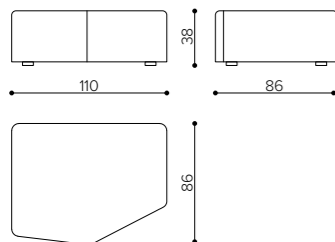

# m 2,6 ☼ mq 5,2 📦 kg 26 🛠 mc 0,4

**ST C00L**  
left module C  
modulo C sinistro  
module C gauche

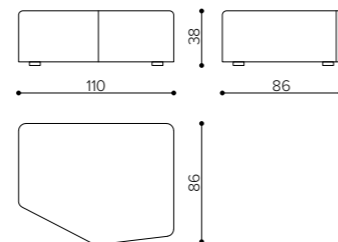

# m 2,6 ☼ mq 5,2 📦 kg 26 🛠 mc 0,4

**ST G000**  
backrest, module G  
schienale, modulo G  
dossier, module G

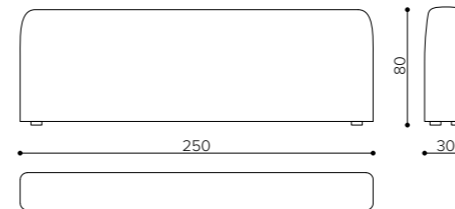

# m 5,2 ☼ mq 10,5 📦 kg 46 🛠 mc 0,6

**ST H000**  
armrest, module H  
bracciolo, modulo H  
accoudoir, module H

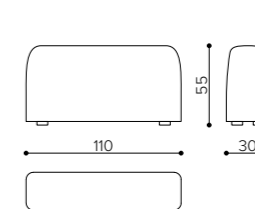

# m 1,8 ☼ mq 3,6 📦 kg 14 🛠 mc 0,18

**ST 100R**  
freestanding right module pouf  
modulo pouf destro autoportante  
module pouf autoportant droit

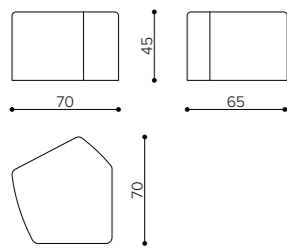

# m 1,65 ☆ mq 2,9 🛒 kg 16 🛠 mc 0,2

**ST 100L**  
freestanding left module pouf  
modulo pouf sinistro autoportante  
module pouf autoportant gauche

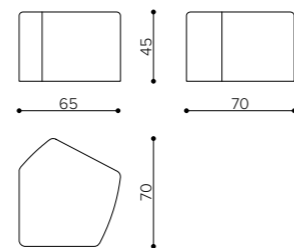

# m 1,65 ☆ mq 2,9 🛒 kg 16 🛠 mc 0,2

**ST JJ00**  
junction element  
elemento di collegamento  
élément de connexion

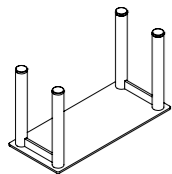
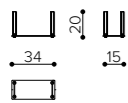

**CONFIGURATION EXAMPLE 1**

ESEMPIO COMPOSIZIONE 1 - EXEMPLE CONFIGURATION 1

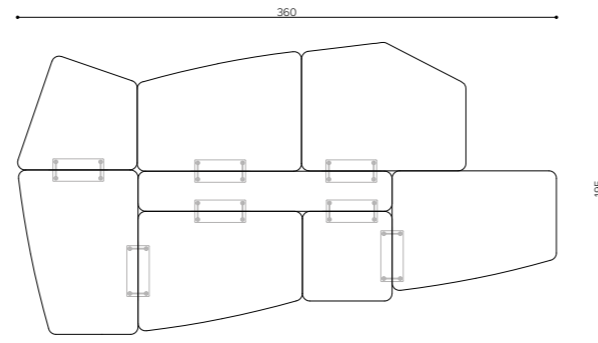
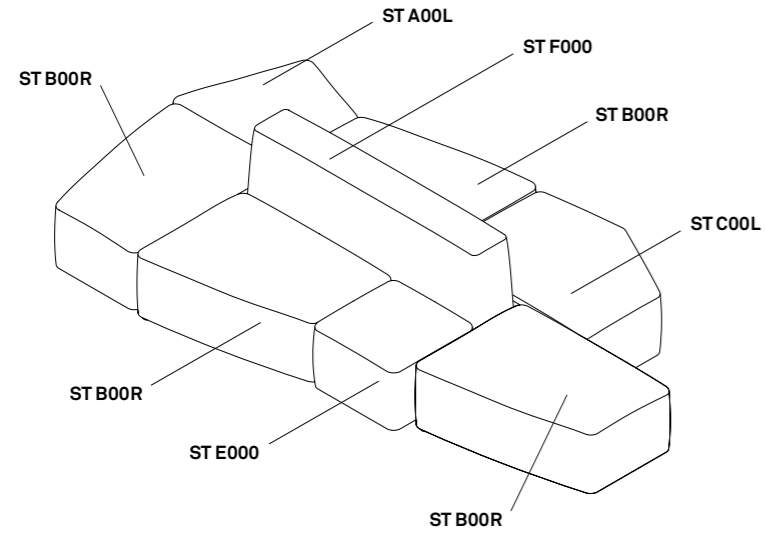

**CONFIGURATION EXAMPLE 2**

ESEMPIO COMPOSIZIONE 2 - EXEMPLE CONFIGURATION 2

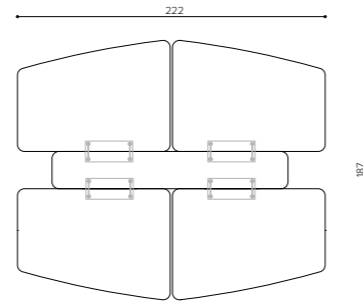
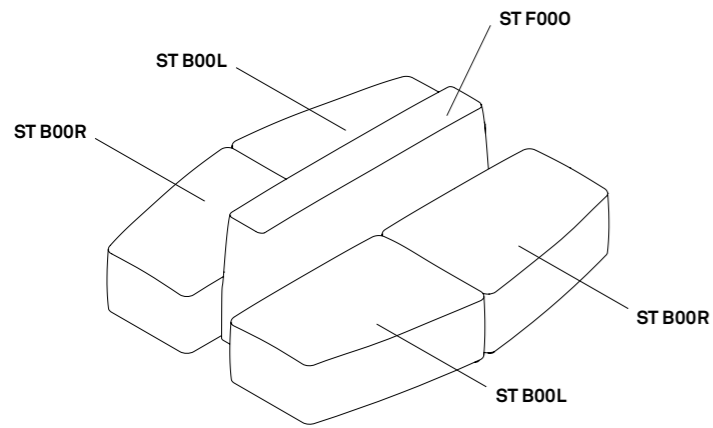

**CONFIGURATION EXAMPLE 3**

ESEMPIO COMPOSIZIONE 3 - EXEMPLE CONFIGURATION 3

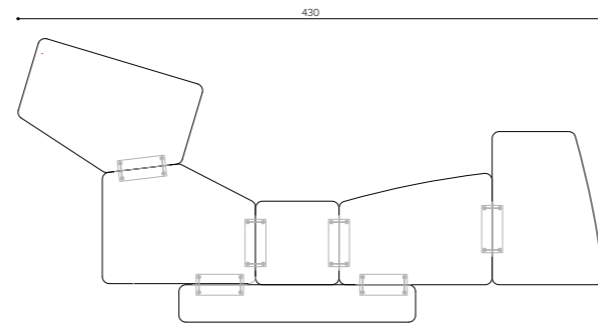
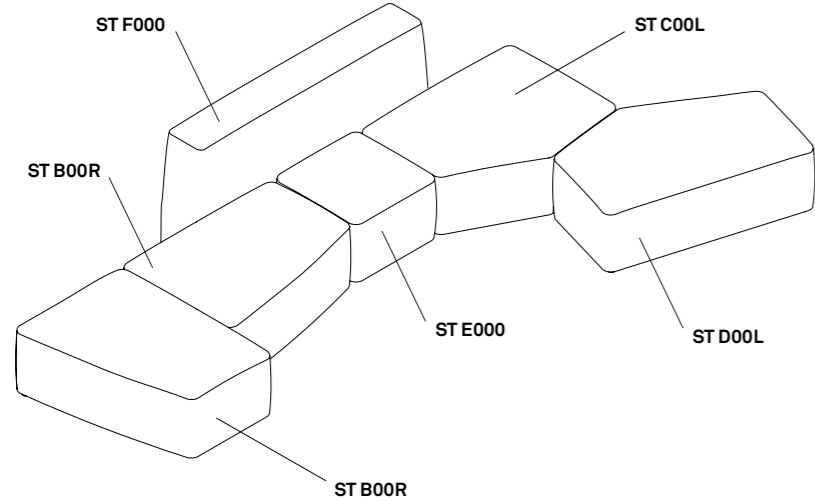

true

# UPHOLSTERY CATEGORIES

CATEGORIE RIVESTIMENTI - CATÉGORIES DE TISSUS D'AMEUBLEMENT

|           |                     |                             |   |
|-----------|---------------------|-----------------------------|---|
| S         | <b>camira</b>       | GRAVITY                     | 76% Polyester, 24% Recycled Polyester, non metallic dyestuffs<br>76% Poliestere, 24% Poliestere riciclato, coloranti non metallici<br>76% Polyester, 24% Polyester recyclé, colorants non métalliques |
|           | <b>camira</b>       | ERA                         | 100% Polyester<br>100% Poliestere - 100% Polyester  |
|           | FIDIVI              | LASER N                     | 100% Polyester Trevira CS<br>100% Poliestere Trevira CS - 100% Polyester Trevira CS   |
|           | FIDIVI              | ONE                         | 100% Recycled polyester<br>100% Poliestere riciclato - 100% Polyester recyclé   |
| T         | FIDIVI              | MAYA                        | 100% Polyester Trevira CS<br>100% Poliestere Trevira CS - 100% Polyester Trevira CS   |
|           | FIDIVI              | SEALIFE                     | 100% Recycled Polyester<br>100% Poliestere riciclato - 100% Polyester recyclé   |
|           | FIDIVI              | CORTE                       | 100% Polyester Trevira CS<br>100% Poliestere Trevira CS - 100% Polyester Trevira CS   |
|           | <b>SPRADLING®</b>   | VALENCIA                    | Vinyl / Urethane Topcoat<br>Finitura in vinile / uretano - Revêtement de finition vinyle / uréthane   |
| M         | <b>camira</b>       | MAIN LINE FLAX              | 70% Virgin Wool, 30% Flax<br>70% Lana Vergine, 30% Lino - 70% Laine vierge, 30% Lin   |
|           | <b>camira</b>       | MAIN LINE TWIST             | 75% Virgin Wool, 25% Flax<br>75% Lana Vergine, 25% Lino - 75% Laine vierge, 25% Lin   |
|           | FIDIVI              | LASER J & J FLASH           | 100% Polyester Trevira CS<br>100% Poliestere Trevira CS - 100% Polyester Trevira CS   |
|           | <b>kvadrat</b>      | FIELD 2                     | 100% Polyester Trevira CS<br>100% Poliestere Trevira CS - 100% Polyester Trevira CS   |
| F         | <b>Gabriel</b>      | FOCUS                       | 100% New Zealand wool<br>100% lana della Nuova Zelanda - 100% laine de Nouvelle-Zélande   |
|           | <b>Gabriel</b>      | FOCUS MELANGE               | 100% New Zealand wool<br>100% lana della Nuova Zelanda - 100% laine de Nouvelle-Zélande   |
|           | <b>Gabriel</b>      | GRAIN                       | 92% Post-consumer recycled polyester, 8% Polyester<br>92% Poliestere riciclato, 8% Poliestere<br>92% Polyester recyclé, 8% Polyester  |
|           | <b>camira</b>       | SYNERGY                     | 95% Virgin Wool, 5% Polyamide<br>95% Lana Vergine, 5% Poliammide - 95% Laine vierge, 5% Polyamide   |
| L         | <b>mariosirtori</b> | RICCIOLONE                  | 56% Acrylic, 15% Polyester, 12% Viscose, 11% Cotton, 6% Flax<br>56% Acrilico, 15% Poliestere, 12% Viscosa, 11% Cotone, 6% Lino<br>56% Acrylique, 15% Poliestère, 12% Viscose, 11% Coton, 6% Line      |
|           | <b>Gabriel</b>      | FOCUS ROYAL                 | 100% New Zealand wool<br>100% Lana della Nuova Zelanda - 100% Laine de Nouvelle-Zélande   |
|           | <b>kvadrat</b>      | REMIX 3                     | 90% New wool (worsted), 10% Nylon<br>90% Lana vergine (pettinata), 10% Nylon - 90% Laine vierge (peignée), 10% Nylon  |
|           | <b>FLUKSO</b>       | GORGEUS                     | 50% PES FR - 50% TREVIRA® CS<br>50% PES FR - 50% TREVIRA® CS - 50% PES FR - 50% TREVIRA® CS   |
| L         | <b>mariosirtori</b> | MONTREAL                    | 65% Wool, 24% Cotton, 6% Other Fibers, 5% Polyester<br>65% Lana, 24% Cotone, 6% Altre fibre, 5% Poliestere<br>65% Laine, 24% Coton, 6% Autres fibres, 5% Polyester                                    |
|           | <b>kvadrat</b>      | TONUS 4                     | 90% New wool, 10% Helanca<br>90% Pura lana vergine, 10% Helanca - 90% Pure laine vierge, 10% Helanca  |
|           | <b>camira</b>       | CRAGGAN FLAX                | 85% Wool, 10% Flax, 5% Polyamide<br>85% Lana, 10% Lino, 5% Poliammide - 85% Laine, 10% Line, 5% Polyamide   |
|           | <b>P</b>            | <b>DANI</b>                 | PANAMA GENUINE LEATHER  |
| <b>PX</b> | <b>elmo</b>         | BALTIQUE FULL GRAIN LEATHER | European bovine leather<br>Pelle bovina europea - Cuir de bovin européen  |

# OUTDOOR UPHOLSTERY CATEGORIES

CATEGORIE RIVESTIMENTI OUTDOOR - CATÉGORIES DE TISSUS D'AMEUBLEMENT OUTDOOR

|   |                   |                |   |
|---|-------------------|----------------|---|
| M | <b>SPRADLING®</b> | MAGLIA         | Vinyl / Urethane Topcoat<br>Finitura in vinile / uretano - Revêtement de finition vinyle / uréthane |
|   | <b>F</b>          | <b>RUBELLI</b> | FIFTYSHADES   |
| L | <b>RUBELLI</b>    | DIECIELODE     | 100% PL flame retardant<br>100% PL ignifugo - 100% PL ignifuge                                      |
|   | <b>RUBELLI</b>    | FABTHIRTY      | 100% PL flame retardant<br>100% PL ignifugo - 100% PL ignifuge                                      |

**Inspire. Create. Deliver.**