

SHELL

Flexibility and simple installation behind a brilliant design. Compose it into the room's corner or hang above a brainstorm table.



ABSORPTION



MEDIUM
& HIGH TONES

MUTE.

SHAPE AND DIMENSIONS mm

+/- 2 mm **WEIGHT 6 kg**

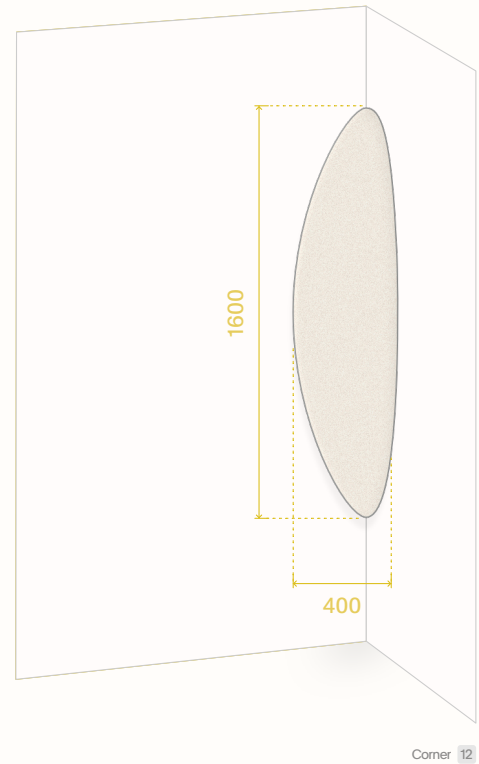
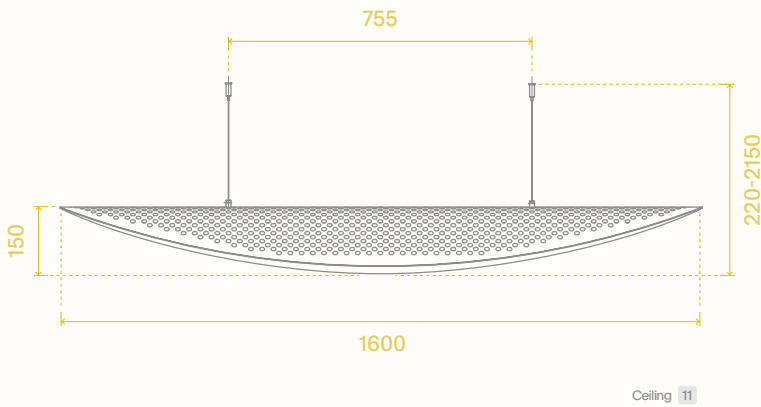

COMPOSITION

- Fabrics of choice
- Melamine foam
- Powder coated steel

FIXING SYSTEMS

Shell can be installed horizontally from the ceiling or vertically in the corner.



• Screws to attach all types of fixing systems to the wall or ceiling are not included in the fixing system set. Select the appropriate anchors and screws for the type of surface.

USAGE

- Open space
- Call center
- Conference room
- Reception
- Breakout area
- Restaurant

PACKING

Shell is packed in a box with dimensions 400 × 400 × 1650 mm.









STEEL BACK COLORS

The sound absorbing surface is placed in a perforated metal back. Available in two basic matt colors and seven ultra matt colors listed below:

 Powder Grey Ultra Matt RAL 7035	 New York Grey Ultra Matt NCS S 3000-N
 Pepper Grey Ultra Matt RAL 7012	 Panther Black Ultra Matt RAL 9005
 Ceramic Red Ultra Matt NCS S 4050-Y70R	 Dusk Blue Ultra Matt NCS S 4010-B50G
 St. Tropez Yellow Ultra Matt RAL 1018	 Snow White Ultra Matt RAL 9003

SELECTION OF STANDARD FABRICS

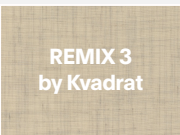
 THE ENTIRE COLOR PALLETTE IS AVAILABLE ON [HTTPS://MUTE.DESIGN](https://mute.design)

NAME	PG	COMPOSITION	WEIGHT g/m ²	WIDTH mm	FLAMMABILITY	ABRASION RES. Martindale cycles	PILLING RES.
 ERA by Camira	1	100% polyester	320	140	BS EN 1021-1 BS EN 1021-2	100 k	4
 EVO		100% polyester	300	160	BS EN 1021-1 BS EN 1021-2	150 k	5
 MEDLEY by Gabriel	2	100% polyester	364	140	BS EN 1021-1 BS EN 1021-2	75 k	5-7
 MICA by Gabriel		97% post-cons. recycled polyester, 3% polyester	218	140	BS EN 1021-1 BS EN 1021-2	60 k	4-5
 SPRINT by Camira		100% polyester	325	150	BS EN 1021-1 BS EN 1021-2	170 k	4
 CHILI by Gabriel	3	75% post-cons. recycled polyester, 25% polyester	336	140	BS EN 1021-1 BS EN 1021-2 DIN 4102-B1	60 k	4-5
 SYNERGY by Camira		95% new wool, 5% polyamide	400	140	BS EN 1021-1 BS EN 1021-2	100 k	4
 REMIX 3 by Kvadrat	4	90% new wool, 10% nylon	300	140	BS EN 1021-1 BS EN 1021-2	100 k	3-4
 SELECT by Gabriel		85% New Zealand wool, 15% polyamide	364	140	BS EN 1021-1 BS EN 1021-2	200 k	4-5
 STEELCUT TRIO 3 by Kvadrat	5	90% new wool, 10% nylon	550	140	BS EN 1021-1 BS EN 1021-2	100 k	4

CARE

- Keep the product dry and away from air conditioning and ventilation systems
- Keep away from direct sun light and heat sources
- Vacuum regularly

Inspire | Create | Deliver

P4.