



# TOWER

The hero product delivering unmatched properties of absorbing excessive noise and total placement flexibility.



ABSORPTION



LOW, MEDIUM  
& HIGH TONES

**MUTE.**

SHAPES AND DIMENSIONS mm

+/- 5 mm

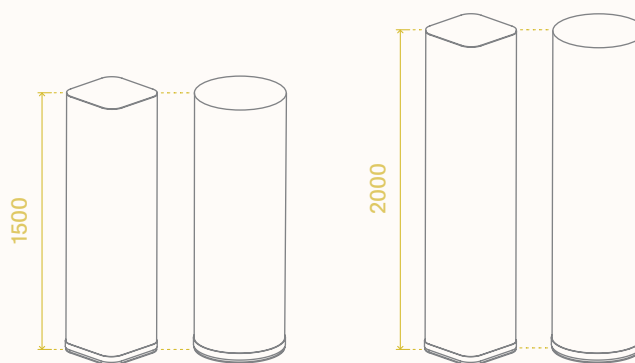
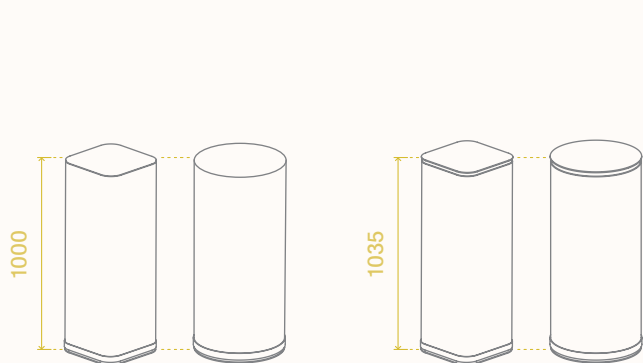

VERSIONS & WEIGHTS

SHAPE	VERSION	HEIGHT mm	WEIGHT kg
Cube <sup>11</sup> 360×360	Standard	1000	2,7
	Tabletop	1035	9
	Tabletop with induction charger	1035	9,7
Cylinder <sup>12</sup> Ø380	Standard	1500	3,7
	Standard	2000	4,9

COMPOSITION

- Fabrics of choice
- Melamine foam
- Powder coated steel

ADDITIONAL TABLETOP

Plywood covered with veneer, premium laminate resistant to fingerprints or standard laminate available in the following variants:

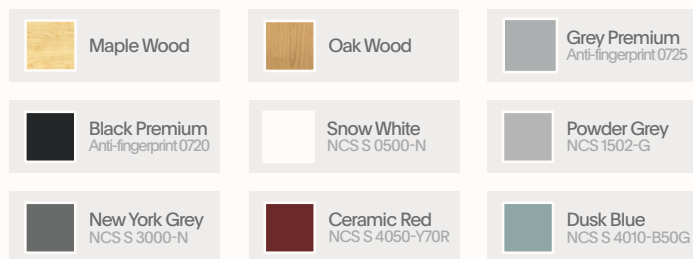

OPTIONAL WIRELESS CHARGER

A circle Qi induction charger can be mounted on a tabletop in 1000 mm version only. The cover and supplying 2-meters wire are available in black.

The electric wire for the induction charger is type FR. Other electrical standards should be marked on the order.

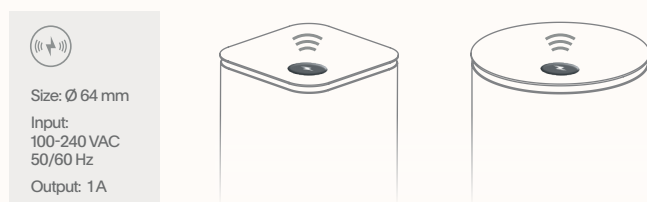

SOUND ABSORPTION A<sub>obj</sub> PER ISO 354 FOR TOWER 2000

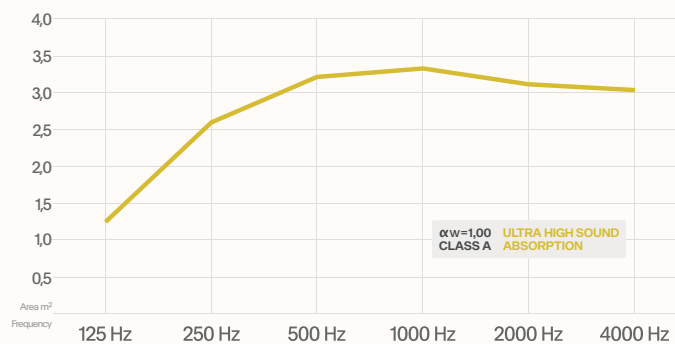

STAND COLORS

The sound absorbing surface is placed in a metal base with a width exceeding 2 millimeters beyond its walls. Available in eight colors.

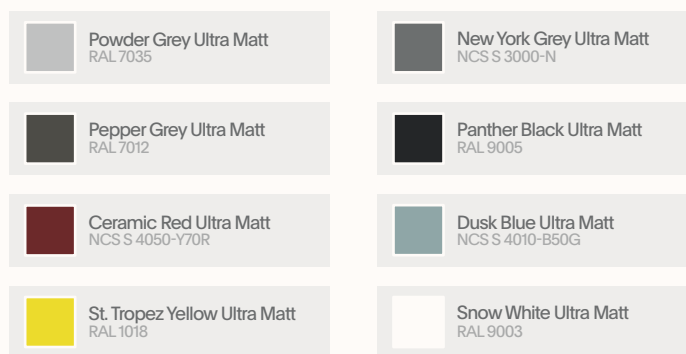

USAGE

- Conference rooms
- Small and medium rooms









PACKING

Depending on the size of the product (1000 mm, 1500 mm, 2000 mm), the appropriate package size is chosen:

- 400 × 400 × 1130
- 400 × 400 × 1530
- 400 × 400 × 2020

## SELECTION OF STANDARD FABRICS

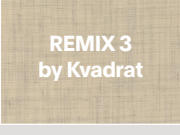
 THE ENTIRE COLOR PALETTE IS AVAILABLE ON [HTTPS://MUTE.DESIGN](https://mute.design)

NAME	PG	COMPOSITION	WEIGHT g/m <sup>2</sup>	WIDTH mm	FLAMMABILITY	ABRASION RES. Martindale cycles	PILLING RES.
 ERA by Camira	1	100% polyester	320	140	BS EN 1021-1 BS EN 1021-2	100 k	4
 EVO		100% polyester	300	160	BS EN 1021-1 BS EN 1021-2	150 k	5
 MEDLEY by Gabriel	2	100% polyester	364	140	BS EN 1021-1 BS EN 1021-2	75 k	5-7
 MICA by Gabriel		97% post-cons. recycled polyester, 3% polyester	218	140	BS EN 1021-1 BS EN 1021-2	60 k	4-5
 SPRINT by Camira		100% polyester	325	150	BS EN 1021-1 BS EN 1021-2	170 k	4
 CHILI by Gabriel	3	75% post-cons. recycled polyester, 25% polyester	336	140	BS EN 1021-1 BS EN 1021-2 DIN 4102-B1	60 k	4-5
 SYNERGY by Camira		95% new wool, 5% polyamide	400	140	BS EN 1021-1 BS EN 1021-2	100 k	4
 REMIX 3 by Kvadrat	4	90% new wool, 10% nylon	300	140	BS EN 1021-1 BS EN 1021-2	100 k	3-4
 SELECT by Gabriel		85% New Zealand wool, 15% polyamide	364	140	BS EN 1021-1 BS EN 1021-2	200 k	4-5
 STEELCUT TRIO 3 by Kvadrat	5	90% new wool, 10% nylon	550	140	BS EN 1021-1 BS EN 1021-2	100 k	4

## CARE

- Keep the product dry and away from air conditioning and ventilation systems
- Keep away from direct sun light and heat sources
- Vacuum regularly
- Do not put anything heavier than 4 kg on the tabletop

Inspire | Create | Deliver

P4.