

# ABISKO

Claesson Koivisto Rune

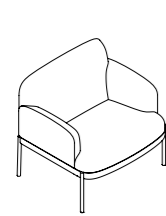

**ARMCHAIR**  
POLTRONA - FAUTEUIL

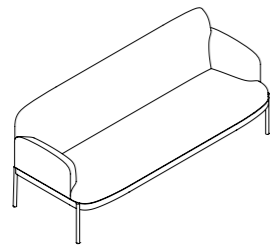

**2 SEATER SOFA**  
DIVANO - CANAPÉ

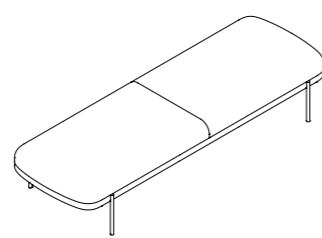

**BENCH**  
PANCA - BANC

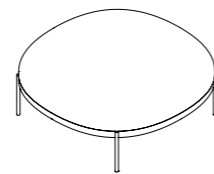

**ROUND BENCH**  
PANCA CIRCOLARE - BANC CIRCULAIRE

## COLORS AND MATERIALS

COLORI E MATERIALI - COULEURS ET MATÉRIAUX

### WOOD LEGNO - BOIS



oakwood  
rovere  
chêne

The standard finish is oakwood.  
Customized RAL colors are available upon request.

La finitura standard è il rovere.  
Colori RAL personalizzati sono disponibili su richiesta.

La finition standard est le chêne.  
Sur demande, d'autres couleurs spéciales sont disponibles en RAL.

### LACQUERED MDF FRAME

STRUTTURA IN MDF LACCATO - STRUCTURE EN MDF LAQUÉ



MDF  
MDF  
MDF

### STEEL FEET

PIEDI IN ACCIAIO - PIEDS EN ACIER



Click on the icon to see the standard RAL finishings for the steel bases on the dedicated page. Customized RAL colors finishings are available upon request.

Clicca sull'icona per vedere le finiture RAL standard delle basi in acciaio sulla pagina dedicata. Su richiesta sono disponibili colorazioni customizzate su altre tinte RAL.

Cliquez sur l'icône pour voir les finitions RAL standard des bases en acier sur la page dédiée. Des couleurs RAL personnalisées sont disponibles sur demande.

## TECHNICAL FEATURES

SPECIFICHE TECNICHE - SPÉCIFICATIONS TECHNIQUES

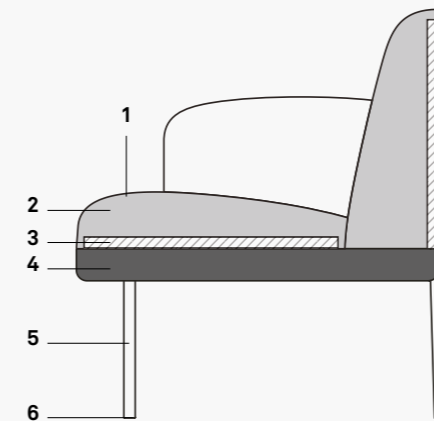

### 1. Upholstery

Rivestimento  
Revêtement

### 2. High resistance foam

Poliuretano espanso indeformabile  
Mousse haute densité

### 3. Wooden inner frame

Struttura interna in legno  
Structure interne en bois

### 4. Solid oak or MDF frame edge

Struttura esterna in rovere massello o MDF  
Structure extérieure en chêne massif ou MDF

### 5. Steel tube legs

Gambe in tubo d'acciaio  
Pieds en tube d'acier

### 6. Felt pad

Feltrino  
Freutre

Internal structure in multilayer wood, polyurethane foam padding; external structure in solid oakwood and frame with 4 varnished steel legs.

Struttura interna in multistrato, imbottitura in poliuretano espanso; struttura esterna in rovere massello e telaio con 4 gambe in acciaio verniciato.

Structure interne en contreplaqué, rembourrage en mousse polyuréthane; structure extérieure en chêne massif et structure à 4 pieds en acier peint.

## COFFEE TABLE VARIANTS

VARIANTI TAVOLINO - VARIANTES DE TABLE BASSE



### Available for the two front legs

Disponibile per le due gambe anteriori  
Disponible pour les deux pieds avant

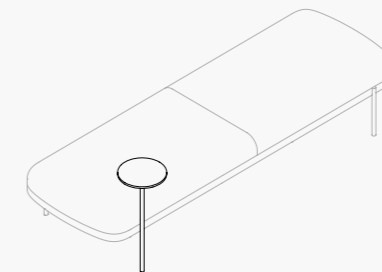

### Available for all legs

Disponibile per tutte le gambe  
Disponible pour tout le pieds

**AB 1000**  
armchair  
poltrona  
fauteuil

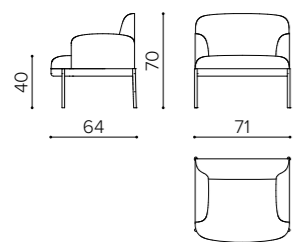

# m 2,15 ☆ mq 4 📦 kg 18,5 📏 mc 0,3

**AB 5P0R**  
pouf  
pouf  
pouf

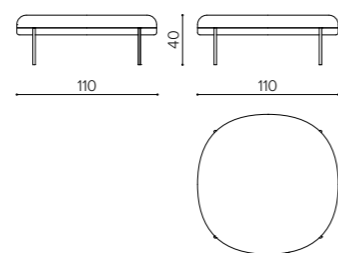

# m 2,4 ☆ mq 4 📦 kg 20 📏 mc 0,4

**AB PSB2**  
USB 5V A+C, 2 mt. of cable, power socket  
USB 5V A+C, 2 mt. di cavo, presa corrente  
USB 5V A+C, 2 mt. de câble, prise de courant

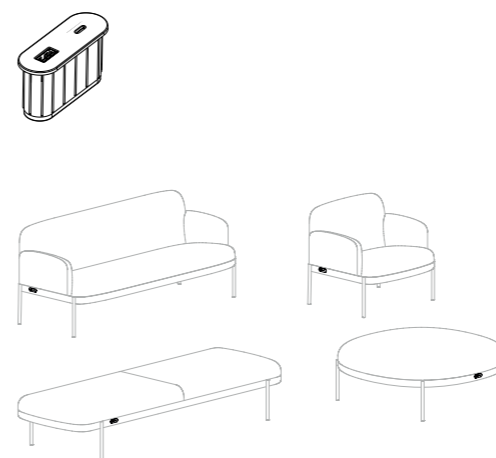

**AB T25FS**  
coffee table  
tavolino  
table basse

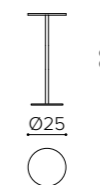

📦 kg 0,6 📏 mc 0,05

**AB 2000**  
2 seater sofa  
divano 2 posti  
canapé 2 places

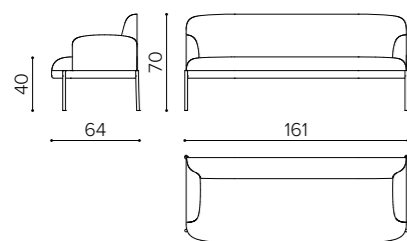

# m 3,6 ☆ mq 6,6 📦 kg 36 📏 mc 0,7

**AB 3P00**  
bench  
panca  
banc

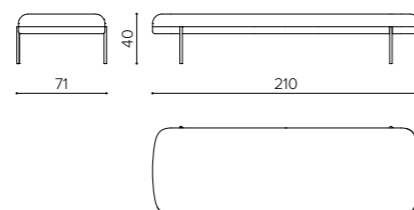

# m 2,4 ☆ mq 4 📦 kg 30 📏 mc 0,59

**AB T25R**  
coffee table  
tavolino  
table basse

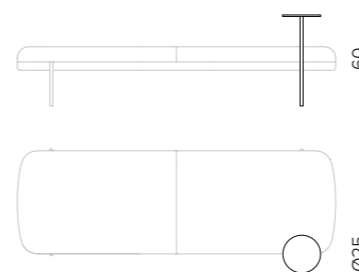

📦 kg 0,2 📏 mc 0,05

**AB CXT25**  
central coffee table  
tavolino centrale  
table basse centrale

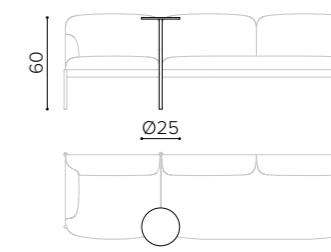

📦 kg 0,2 📏 mc 0,05

**AB 3000**  
3 seater sofa  
divano 3 posti  
canapé 3 places

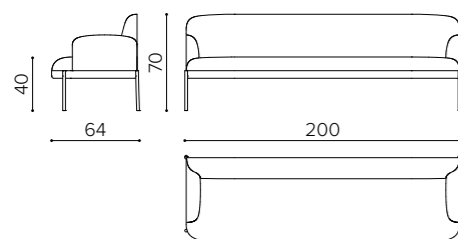

# m 5,5 ☆ mq 10

**AB 1L00**  
left armchair  
poltrona sinistra  
fauteuil gauche

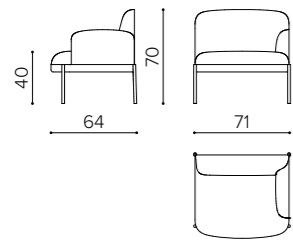

# m 1,65    ☆ mq 3,2    📦 kg 17,5    🛠 mc 0,3

**AB 1R00**  
right chair  
poltrona destra  
fauteuil droit

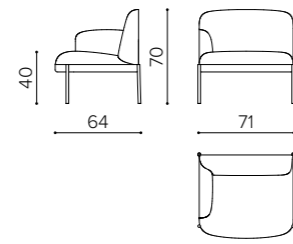

**AB 1C00**  
central armchair  
poltrona centrale  
fauteuil central

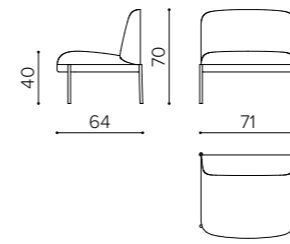

# m 1,8    ☆ mq 4    📦 kg 16,5    🛠 mc 0,3

**AB L140**  
left sofa  
divano sinistro  
canapé gauche

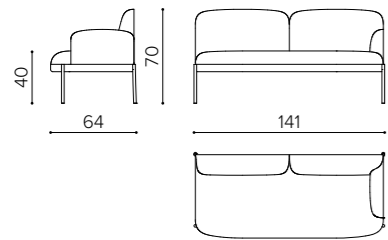

# m 5    ☆ mq 10    📦 kg 30    🛠 mc 0,63

**AB R140**  
right sofa  
divano destro  
canapé droit

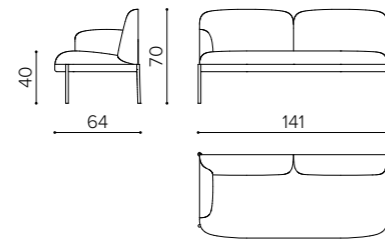

**AB C140**  
central sofa  
divano centrale  
canapé central

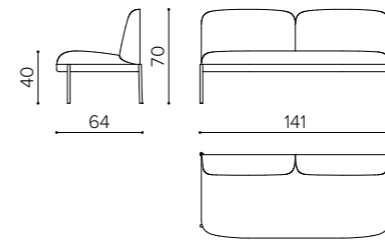

# m 4,6    ☆ mq 9    📦 kg 29    🛠 mc 0,63

**AB L160**  
left sofa  
divano sinistro  
canapé gauche

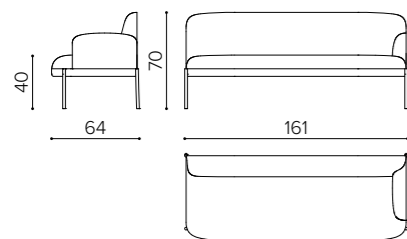

# m 4,4    ☆ mq 9    📦 kg 35    🛠 mc 0,7

**AB R160**  
right sofa  
divano destro  
canapé droit

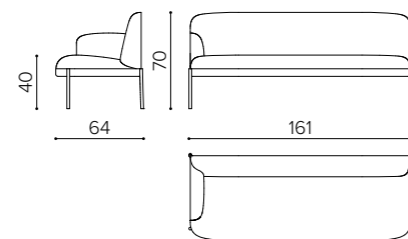

**AB C160**  
central sofa  
divano centrale  
canapé central

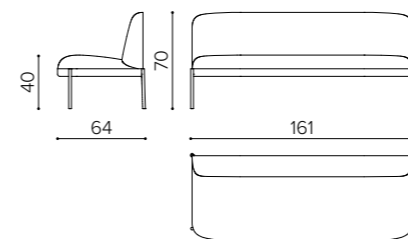

# m 4    ☆ mq 8    📦 kg 34    🛠 mc 0,7

**AB 90CV**  
central sofa  
divano centrale  
canapé central

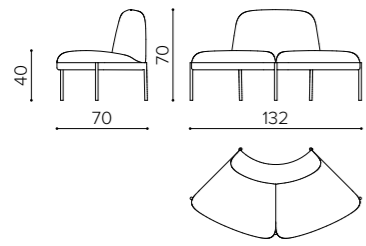

# m 1,65    ☆ mq 3,2    ✎ mc 0,64

**AB 45CV**  
central sofa  
divano centrale  
canapé central

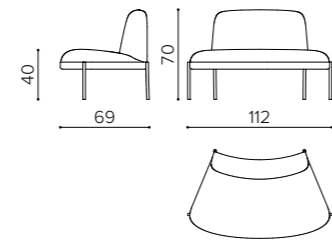

# m 1,65    ☆ mq 3,2    ✎ mc 0,54

**AB 90CX**  
central sofa  
divano centrale  
canapé central

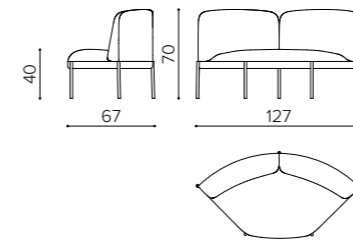

# m 1,65    ☆ mq 3,2    ✎ mc 0,59

**AB 45CX**  
central sofa  
divano centrale  
canapé central

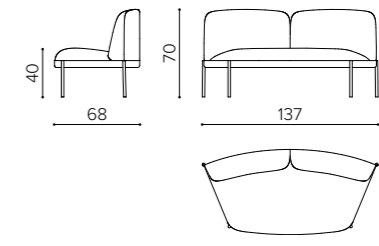

# m 1,65    ☆ mq 3,2    ✎ mc 0,65

**AB 90CVR/L**  
terminal sofa  
divano terminale  
canapé terminal

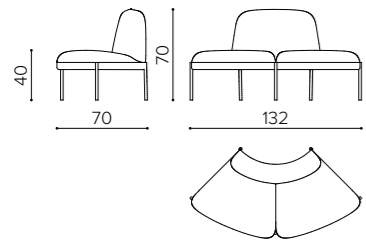

# m 5    ☆ mq 10    ✎ mc 0,63

**AB 45CVR/L**  
terminal sofa  
divano terminale  
canapé terminal

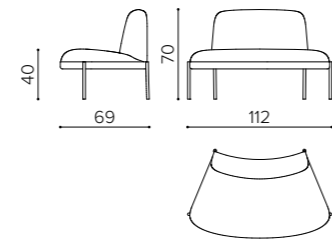

# m 5    ☆ mq 10    ✎ mc 0,54

**AB 90CXR/L**  
terminal sofa  
divano terminale  
canapé terminal

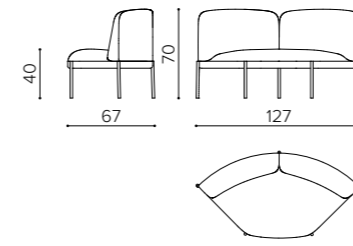

# m 5    ☆ mq 10    ✎ mc 0,59

**AB 45CXR/L**  
terminal sofa  
divano terminale  
canapé terminal

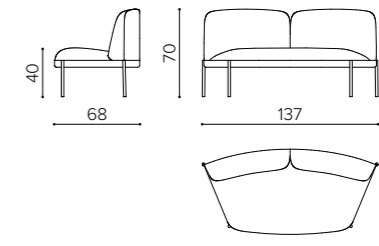

# m 5    ☆ mq 10    ✎ mc 0,65

**AB TCXO**  
coffee table  
tavolino  
table basse

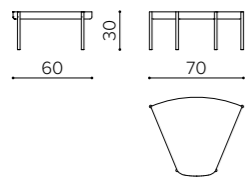

# m 4,4    ✎ mc 0,12

**AB TCVO**  
coffee table  
tavolino  
table basse

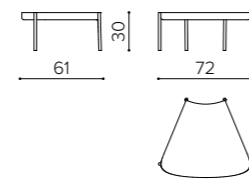

# m 4,4    ✎ mc 0,13

**AB TCSO**  
coffee table  
tavolino  
table basse

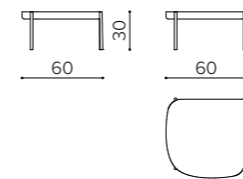

# m 4,4    ✎ mc 0,1

**AB TCCO**  
coffee table  
tavolino  
table basse

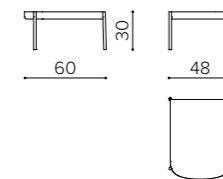

# m 4,4    ✎ mc 0,08

**CONFIGURATION EXAMPLE 1**

ESEMPIO COMPOSIZIONE 1 - EXEMPLE CONFIGURATION 1

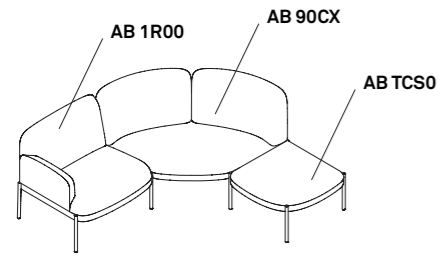

216 W x 115 D x 70 H

**CONFIGURATION EXAMPLE 2**

ESEMPIO COMPOSIZIONE 2 - EXEMPLE CONFIGURATION 2

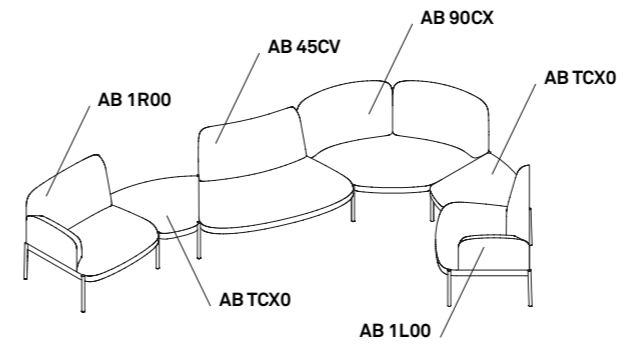

340 W x 187 D x 70 H

**CONFIGURATION EXAMPLE 3**

ESEMPIO COMPOSIZIONE 3 - EXEMPLE CONFIGURATION 3

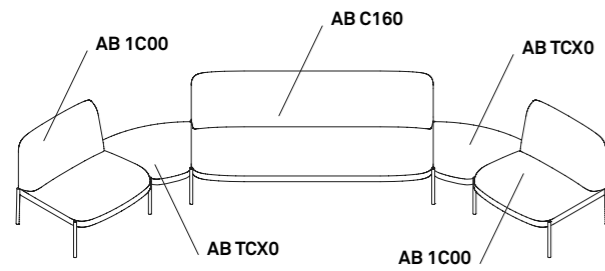

388 W x 115 D x 70 H

**CONFIGURATION EXAMPLE 4**

ESEMPIO COMPOSIZIONE 4 - EXEMPLE CONFIGURATION 4

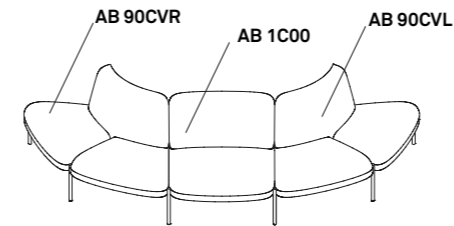

261 W x 100 D x 70 H

**CONFIGURATION EXAMPLE 5**

ESEMPIO COMPOSIZIONE 5 - EXEMPLE CONFIGURATION 5

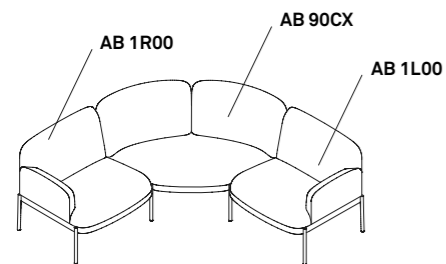

226 W x 115 D x 70 H

**CONFIGURATION EXAMPLE 6**

ESEMPIO COMPOSIZIONE 6 - EXEMPLE CONFIGURATION 6

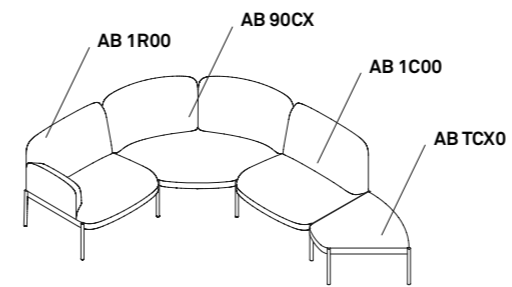

253 W x 140 D x 70 H

**CONFIGURATION EXAMPLE 7**

ESEMPIO COMPOSIZIONE 7 - EXEMPLE CONFIGURATION 7

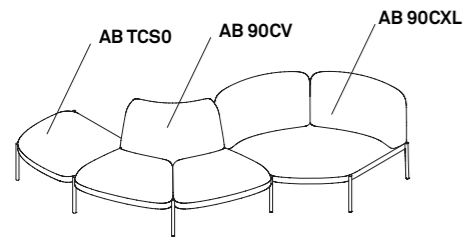

257 W x 105 D x 70 H

**CONFIGURATION EXAMPLE 8**

ESEMPIO COMPOSIZIONE 8 - EXEMPLE CONFIGURATION 8

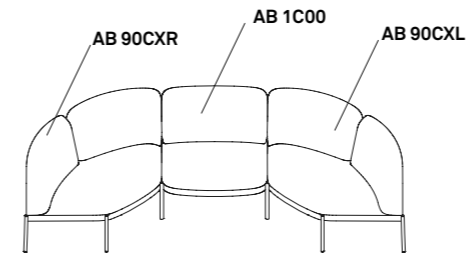

350 W x 90 D x 70 H

**CONFIGURATION EXAMPLE 9**

ESEMPIO COMPOSIZIONE 9 - EXEMPLE CONFIGURATION 9

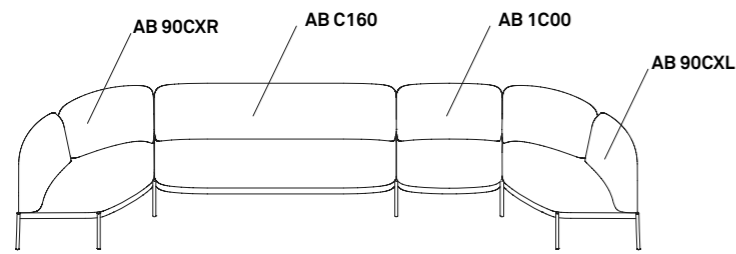

410 W x 90 D x 70 H

**CONFIGURATION EXAMPLE 10**

ESEMPIO COMPOSIZIONE 10 - EXEMPLE CONFIGURATION 10

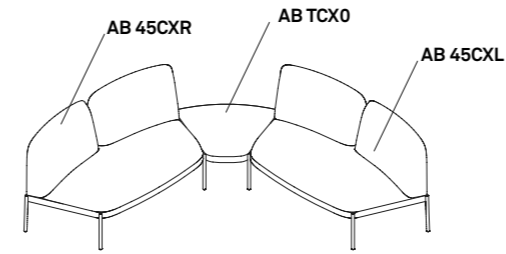

265 W x 125 D x 70 H

**CONFIGURATION EXAMPLE 11**

ESEMPIO COMPOSIZIONE 11 - EXEMPLE CONFIGURATION 11

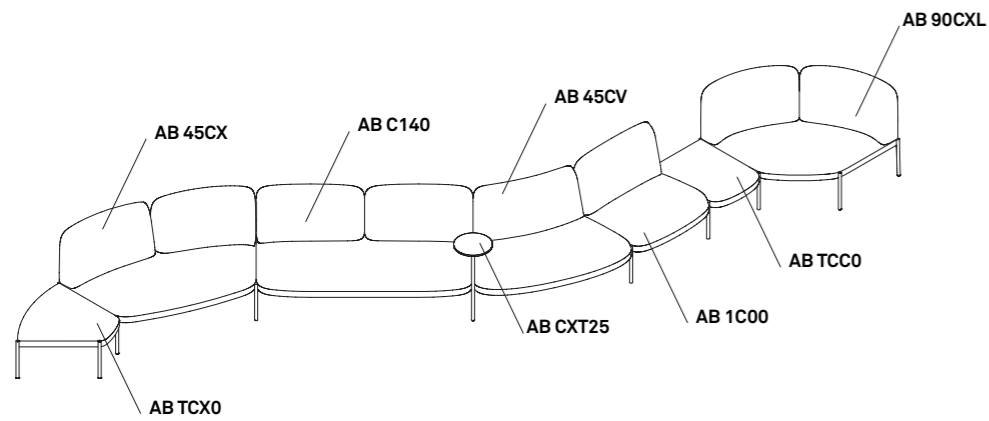

560 W x 270 D x 70 H

**CONFIGURATION EXAMPLE 12**

ESEMPIO COMPOSIZIONE 12 - EXEMPLE CONFIGURATION 12

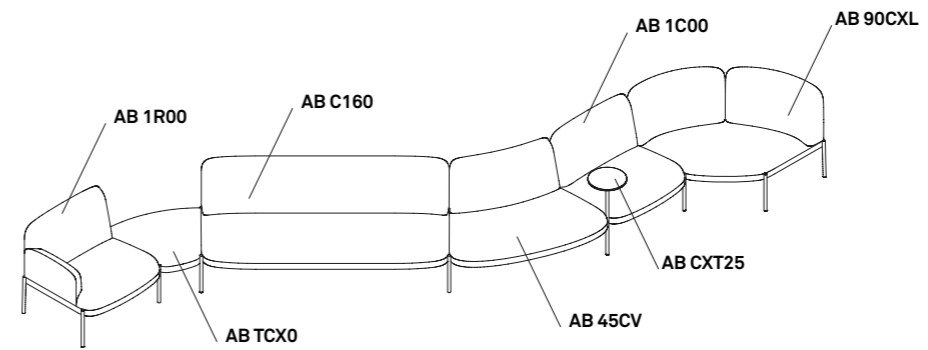

472 x 258 D x 70 H

# UPHOLSTERY CATEGORIES

CATEGORIE RIVESTIMENTI - CATÉGORIES DE TISSUS D'AMEUBLEMENT

S	<b>camira</b>	GRAVITY	76% Polyester, 24% Recycled Polyester, non metallic dyestuffs 76% Poliestere, 24% Poliestere riciclato, coloranti non metallici 76% Polyester, 24% Polyester recyclé, colorants non métalliques
	<b>camira</b>	ERA	100% Polyester 100% Poliestere - 100% Polyester
	FIDIVI	LASER N	100% Polyester Trevira CS 100% Poliestere Trevira CS - 100% Polyester Trevira CS
	FIDIVI	ONE	100% Recycled polyester 100% Poliestere riciclato - 100% Polyester recyclé
T	FIDIVI	MAYA	100% Polyester Trevira CS 100% Poliestere Trevira CS - 100% Polyester Trevira CS
	FIDIVI	SEALIFE	100% Recycled Polyester 100% Poliestere riciclato - 100% Polyester recyclé
	FIDIVI	CORTE	100% Polyester Trevira CS 100% Poliestere Trevira CS - 100% Polyester Trevira CS
	<b>SPRADLING®</b>	VALENCIA	Vinyl / Urethane Topcoat Finitura in vinile / uretano - Revêtement de finition vinyle / uréthane
M	<b>camira</b>	MAIN LINE FLAX	70% Virgin Wool, 30% Flax 70% Lana Vergine, 30% Lino - 70% Laine vierge, 30% Lin
	<b>camira</b>	MAIN LINE TWIST	75% Virgin Wool, 25% Flax 75% Lana Vergine, 25% Lino - 75% Laine vierge, 25% Lin
	FIDIVI	LASER J & J FLASH	100% Polyester Trevira CS 100% Poliestere Trevira CS - 100% Polyester Trevira CS
	<b>kvadrat</b>	FIELD 2	100% Polyester Trevira CS 100% Poliestere Trevira CS - 100% Polyester Trevira CS
F	<b>Gabriel</b>	FOCUS	100% New Zealand wool 100% lana della Nuova Zelanda - 100% laine de Nouvelle-Zélande
	<b>Gabriel</b>	FOCUS MELANGE	100% New Zealand wool 100% lana della Nuova Zelanda - 100% laine de Nouvelle-Zélande
	<b>Gabriel</b>	GRAIN	92% Post-consumer recycled polyester, 8% Polyester 92% Poliestere riciclato, 8% Poliestere 92% Polyester recyclé, 8% Polyester
	<b>camira</b>	SYNERGY	95% Virgin Wool, 5% Polyamide 95% Lana Vergine, 5% Poliammide - 95% Laine vierge, 5% Polyamide
L	<b>mariosirtori</b>	RICCIOLONE	56% Acrylic, 15% Polyester, 12% Viscose, 11% Cotton, 6% Flax 56% Acrilico, 15% Poliestere, 12% Viscosa, 11% Cotone, 6% Lino 56% Acrylique, 15% Poliestère, 12% Viscose, 11% Coton, 6% Line
	<b>Gabriel</b>	FOCUS ROYAL	100% New Zealand wool 100% Lana della Nuova Zelanda - 100% Laine de Nouvelle-Zélande
	<b>kvadrat</b>	REMIX 3	90% New wool (worsted), 10% Nylon 90% Lana vergine (pettinata), 10% Nylon - 90% Laine vierge (peignée), 10% Nylon
	<b>FLUKSO</b>	GORGEUS	50% PES FR - 50% TREVIRA® CS 50% PES FR - 50% TREVIRA® CS - 50% PES FR - 50% TREVIRA® CS
L	<b>mariosirtori</b>	MONTREAL	65% Wool, 24% Cotton, 6% Other Fibers, 5% Polyester 65% Lana, 24% Cotone, 6% Altre fibre, 5% Poliestere 65% Laine, 24% Coton, 6% Autres fibres, 5% Polyester
	<b>kvadrat</b>	TONUS 4	90% New wool, 10% Helanca 90% Pura lana vergine, 10% Helanca - 90% Pure laine vierge, 10% Helanca
	<b>camira</b>	CRAGGAN FLAX	85% Wool, 10% Flax, 5% Polyamide 85% Lana, 10% Lino, 5% Poliammide - 85% Laine, 10% Line, 5% Polyamide
	<b>P</b>	<b>DANI</b>	PANAMA GENUINE LEATHER
<b>PX</b>	<b>elmo</b>	BALTIQUE FULL GRAIN LEATHER	European bovine leather Pelle bovina europea - Cuir de bovin européen

# OUTDOOR UPHOLSTERY CATEGORIES

CATEGORIE RIVESTIMENTI OUTDOOR - CATÉGORIES DE TISSUS D'AMEUBLEMENT OUTDOOR

M	<b>SPRADLING®</b>	MAGLIA	Vinyl / Urethane Topcoat Finitura in vinile / uretano - Revêtement de finition vinyle / uréthane
	<b>F</b>	<b>RUBELLI</b>	FIFTYSHADES
L	<b>RUBELLI</b>	DIECIELODE	100% PL flame retardant 100% PL ignifugo - 100% PL ignifuge
	<b>RUBELLI</b>	FABTHIRTY	100% PL flame retardant 100% PL ignifugo - 100% PL ignifuge

# OUTDOOR USE AND MAINTENANCE

USO E MANUTENZIONE PER L'OUTDOOR - UTILISATION ET MAINTENANCE POUR L'EXTÉRIUR



**STEEL**  
METALLO/MÉTAL

Steel is used in the manufacture of metal products. This material galvanised and powder-coated, is ideal for outdoor use. Regarding products intended for seaside locations we recommend cleaning on a quarterly basis, with a cloth using water or mild detergents. During the winter period we recommend storing the furniture in closed, dry rooms in order to prevent condensation. In fact, although our products are suitable for outdoor use, during colder months the products should be stored in a closed, dry place in order to prevent moisture and seasonal frosts from affecting the finish.

Nella realizzazione dei prodotti metallici viene impiegato l'acciaio, il quale in seguito al processo di zincatura e di verniciatura a polveri, risulta ideale per l'utilizzo outdoor. Durante il periodo invernale consigliamo di conservare gli arredi in luoghi chiusi ed asciutti per evitare la formazione di condensa. Per i prodotti destinati a località marittime consigliamo con cadenza trimestrale una pulizia con un panno utilizzando acqua o detersivi non aggressivi. Nonostante i nostri prodotti siano adatti all'ambiente esterno, durante il periodo invernale è consigliato il ricovero dei prodotti in un luogo chiuso ed asciutto. In modo da evitare che l'umidità unita alle gelate stagionali possa in qualche modo intaccare le finiture.

L'acier est la matière première utilisée dans la fabrication de ces produits métalliques qui, après un processus de galvanisation et un revêtement de finition par poudre, sont idéaux pour une utilisation en extérieur. Pour les produits destinés à être utilisés en bord de mer, nous recommandons un nettoyage trimestriel avec un chiffon utilisant de l'eau ou des détergents doux. Bien que nos produits soient adaptés à un usage extérieur, nous recommandons de les stocker dans un endroit fermé et sec pendant l'hiver; ceci afin d'éviter que l'humidité combinée aux gelées saisonnières n'affecte d'une manière ou d'une autre les finitions.



**STONE**  
PIETRA/PIERRE

The stone tops are made of Marble or Quarella and they are ideal for the outdoor environment. Use a soft cloth with just water for daily cleaning. Avoid the use of aggressive abrasive sponges or steel wool pads. The furnishings made of stone such as marble and Quarella, during the first week of use will undergo a slight dulling due to contact with external elements. This is a natural phenomenon which does not affect the quality of the material. When the furniture is placed in seaside locations or swimming pools, cleaning with fresh water on a quarterly basis is recommended in order to avoid water corrosion due to salt build-up or chlorosis. Although our products are suitable for outdoor use, during colder months the products should be stored in a closed, dry place in order to prevent moisture and seasonal frosts from affecting the finish.

Materiale composito autoportante adatto all'ambiente Outdoor. Utilizzare un panno morbido con sola acqua per la pulizia quotidiana. In caso di necessità utilizzare detersivi non aggressivi. Evitare l'impiego di spugne abrasive o pagliette in acciaio. Nel caso di collocamento degli arredi in località marittime o piscine, si consiglia una pulizia trimestrale utilizzando acqua dolce per evitare principi di corrosione dovuti ad accumuli salini o clorosi. Nonostante i nostri prodotti siano adatti all'ambiente esterno, durante il periodo invernale è consigliato il ricovero dei prodotti in un luogo chiuso ed asciutto. In modo da evitare che l'umidità unita alle gelate stagionali possa in qualche modo intaccare le finiture.

Les dessus en pierre sont en marbre ou en quarella, idéaux pour une utilisation en extérieur. Utilisez un chiffon doux avec de l'eau uniquement pour le nettoyage quotidien. Évitez d'utiliser des détergents agressifs, des éponges abrasives ou des tampons de laine d'acier. Les meubles en pierre tels que le marbre et la Quarella, pendant la première semaine, subissent un léger ternissement dû au contact avec les éléments extérieurs. Il s'agit d'un phénomène naturel, qui n'affecte pas la qualité du matériau. Si le meuble est placé dans des stations balnéaires ou des piscines, nous recommandons un nettoyage trimestriel à l'eau douce pour éviter la corrosion due à l'accumulation de sel ou à la chlorose. Bien que nos produits conviennent à une utilisation en extérieur, il est recommandé, pendant la période hivernale, de stocker les produits dans un endroit fermé et sec, afin d'éviter que l'humidité combinée aux gelées saisonnières n'affecte d'une manière ou d'une autre la finition.



**FABRICS**  
TESSUTI/TISSU

The fabrics used are naturally resistant to climatic elements, UV-resistant and anti-microbial. After heavy rainfall it is recommended to remove the cushions for quick drying and in order to prevent condensation. When the furniture is placed in seaside locations or swimming pools, cleaning with fresh water on a quarterly basis is recommended in order to avoid water corrosion due to salt build-up or chlorosis. Although our products are suitable for outdoor use, during colder months the products should be stored in a closed, dry place in order to prevent moisture and seasonal frosts from affecting the finish.

I tessuti impiegati sono naturalmente resistenti agli elementi climatici, resistenti ai raggi UV ed anti-microbici. A seguito di forti precipitazioni è consigliato rimuovere i cuscini per un'asciugatura rapida e prevenire la formazione di condensa. Nel caso di collocamento degli arredi in località marittime o piscine, si consiglia una pulizia trimestrale utilizzando acqua dolce per evitare principi di corrosione dovuti ad accumuli salini o clorosi. Nonostante i nostri prodotti siano adatti all'ambiente esterno, durante il periodo invernale è consigliato il ricovero dei prodotti in un luogo chiuso ed asciutto. In modo da evitare che l'umidità unita alle gelate stagionali possa in qualche modo intaccare le finiture.

Les tissus utilisés sont naturellement résistants aux éléments climatiques, résistants aux UV et antimicrobiens. Après de fortes pluies, il est toutefois conseillé de retirer les coussins pour un séchage rapide et pour éviter la formation de condensation. Si le mobilier est placé dans des stations balnéaires ou des piscines, nous recommandons un nettoyage trimestriel à l'eau douce pour éviter la corrosion due à l'accumulation de sel ou de chlore. Bien que nos produits soient adaptés à une utilisation en extérieur, il est recommandé de les stocker dans un endroit fermé et sec pendant la période hivernale, afin d'éviter que l'humidité combinée aux gelées saisonnières n'affecte d'une manière ou d'une autre les finitions.

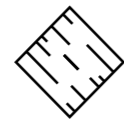

**HPL**  
HPL/HPLR

Self-supporting composite material suitable for outdoor environment. Use a soft cloth with water only for daily cleaning. If necessary, use non-aggressive detergents. Please avoid using abrasive sponges or steel wool pads. When the furniture is placed in seaside locations or swimming pools, cleaning with fresh water on a quarterly basis is recommended in order to avoid water corrosion due to salt build-up or chlorosis. Although our products are suitable for outdoor use, during colder months the products should be stored in a closed, dry place in order to prevent moisture and seasonal frosts from affecting the finish.

Materiale composito autoportante adatto all'ambiente Outdoor. Utilizzare un panno morbido con sola acqua per la pulizia quotidiana. In caso di necessità utilizzare detersivi non aggressivi. Evitare l'impiego di spugne abrasive o pagliette in acciaio. Nel caso di collocamento degli arredi in località marittime o piscine, si consiglia una pulizia trimestrale utilizzando acqua dolce per evitare principi di corrosione dovuti ad accumuli salini o clorosi. Nonostante i nostri prodotti siano adatti all'ambiente esterno, durante il periodo invernale è consigliato il ricovero dei prodotti in un luogo chiuso ed asciutto. In modo da evitare che l'umidità unita alle gelate stagionali possa in qualche modo intaccare le finiture.

Matériau composite autoportant adapté à un usage extérieur. Utilisez un chiffon doux avec de l'eau uniquement pour le nettoyage quotidien. Si nécessaire, utilisez des détergents non agressifs. Évitez d'utiliser des éponges abrasives ou des tampons de laine d'acier. Si le mobilier doit être installé dans des stations balnéaires ou des piscines, nous recommandons un nettoyage trimestriel à l'eau douce pour éviter la corrosion due au sel ou au chlore. Bien que nos produits conviennent à une utilisation en extérieur, il est recommandé, pendant la période hivernale, de stocker les produits dans un endroit fermé et sec, afin d'éviter que l'humidité combinée aux gelées saisonnières n'affecte d'une manière ou d'une autre les finitions.

# STANDARD STEEL RAL COLORS

COLORI RAL STANDARD PER ACCIAIO - COULEURS RAL STANDARD POUR L'ACIER

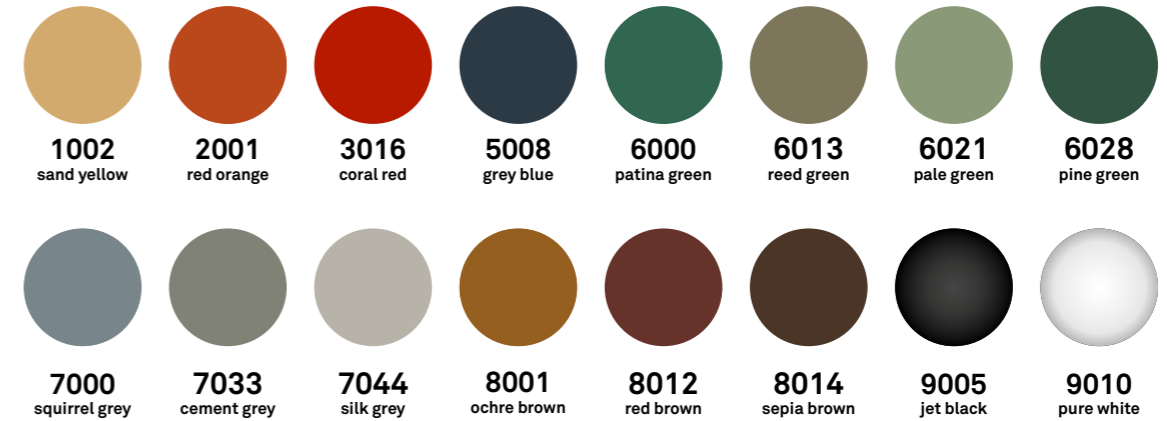

The standard finishings for the steel elements are the RAL shown. Customized RAL colors finishings are available upon request.

Le finiture standard degli elementi in acciaio sono i RAL mostrati. Su richiesta sono disponibili colorazioni customizzate su altre tinte RAL.

Les finitions standard des éléments en acier sont le RAL illustré. Des couleurs RAL personnalisées sont disponibles sur demande.



# MATERIAL FINISHES AND COLOR SWATCHES

FINITURE MATERIALI E CAMPIONI COLORI - FINITIONS ET ÉCHANTILLONS COULEURS

## DOWNLOAD

Click on the image above to download the material finishes and color swatches

Clicca sull'immagine per scaricare il pdf delle finiture dei materiali e dei campioni colori

Cliquez sur l'image associée pour télécharger les finitions et échantillons couleurs





**Inspire. Create. Deliver.**