

# SHO

Favaretto & Partners

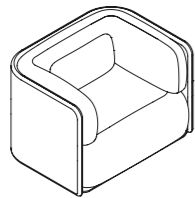

H74



**ARMCHAIR**  
POLTRONA - FAUTEUIL

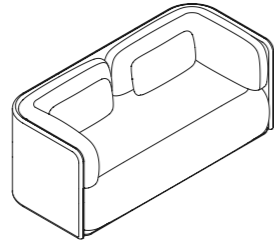

**2 SEATER SOFA**  
DIVANO 2 POSTI - CANAPÉ 2 PLACES

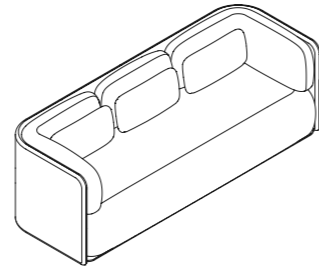

**3 SEATER SOFA**  
DIVANO 3 POSTI - CANAPÉ 3 PLACES

H103

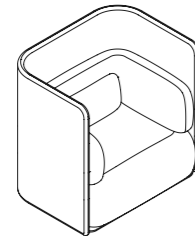

**ARMCHAIR**  
POLTRONA - FAUTEUIL

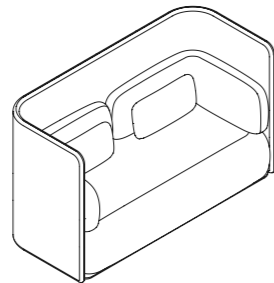

**2 SEATER SOFA**  
DIVANO 2 POSTI - CANAPÉ 2 PLACES

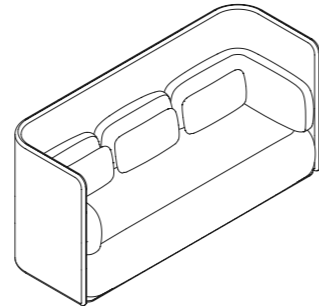

**3 SEATER SOFA**  
DIVANO 3 POSTI - CANAPÉ 3 PLACES

H140

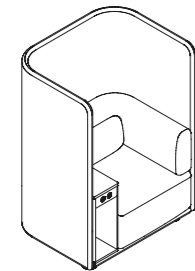

**SHO CLUB**

## TECHNICAL FEATURES

SPECIFICHE TECNICHE - SPÉCIFICATIONS TECHNIQUES

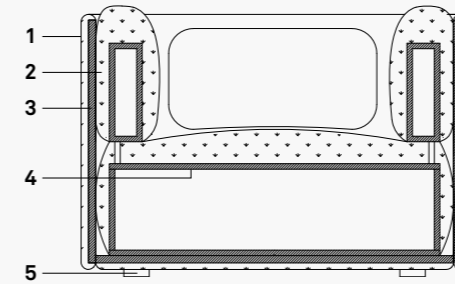

**1. Upholstery**  
Rivestimento  
Revêtement

**2. High resistance foam**  
Poliuretano espanso indeformabile  
Mousse polyuréthane indéformable

**3. Wooden inner frame**  
Struttura interna in legno  
Structure interne en bois

**4. Elastic straps**  
Cinghie elastiche  
Sangles élastiques

**5. Polypropylene feet**  
Piedini in polipropilene  
Pieds en polypropylène

**6. Laminated plywood side cabinet**  
Mobile laterale in multistrato laminato  
Meuble latéral en contreplaqué laminé

**7. Power socket + 2 USB(A+A)**  
Presa di alimentazione + 2 USB(A+A)  
Prises de courant + 2 USB(A+A)

**8. MDF feet**  
Piedini in MDF  
Pieds en MDF

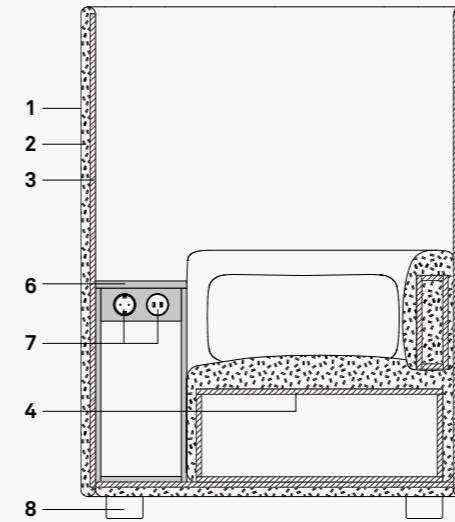

**SHO CLUB**

Inner wooden frame, seat with elastic bands, variable density flexible foam padding. Polypropylene feet.

Fusto in legno, seduta con cinghie elastiche; imbottitura in poliuretano espanso a densità differenziate. Piedini in polipropilene.

Cadre en bois, assise avec ceintures élastiques; rembourrage en mousse de polyuréthane à densité différenciée. Pieds en polypropylène.

**SH 1000**  
armchair  
poltrona  
fauteuil

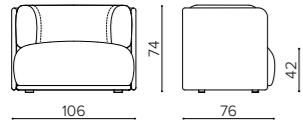

# m 5,45    ☆ mq 10    📦 kg 30    ⚙ mc 0,65

**SH 100H**  
high back armchair  
poltrona con schienale alto  
fauteuil à dossier haut

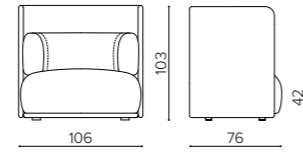

# m 6,9    ☆ mq 13    📦 kg 40    ⚙ mc 0,83

**SH C000**  
soft cushion  
cuscino morbido  
coussin souple

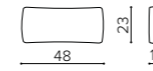

# m 0,65    ☆ mq 1    📦 kg 0,2    ⚙ mc 0,05

**SH 3000**  
3 seater sofa  
divano 3 posti  
canapé 3 places

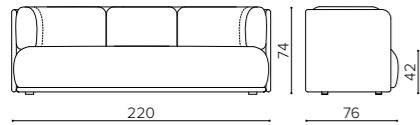

# m 12    ☆ mq 21    📦 kg 55    ⚙ mc 1,3

**SH 300H**  
high back 3 seater sofa  
divano 3 posti con schienale alto  
canapé 3 places à dossier haut

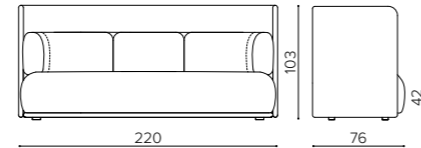

# m 13,5    ☆ mq 25    📦 kg 65    ⚙ mc 1,7

**SH 10CL/L**  
armchair with storage space  
poltrona con vano contenitore  
fauteuil avec espace de rangement

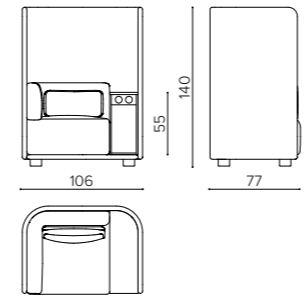

# m 7    ☆ mq 14    ⚙ mc 1,14

**SH PS02**

Power socket + 2 USB(A+A)  
Presa di alimentazione + 2 USB(A+A)  
Prises de courant + 2 USB(A+A)

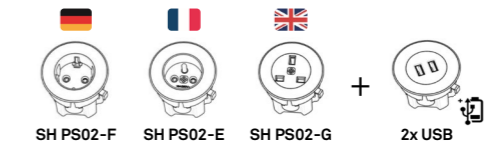

other socket types are available on request  
altre tipologie di prese sono disponibili su richiesta  
autres types de prises de courant sont disponibles sur demande

**SH 2000**  
2 seater sofa  
divano 2 posti  
canapé 2 places

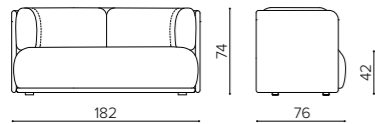

# m 10    ☆ mq 17    📦 kg 40    ⚙ mc 0,9

**SH 200H**  
high back 2 seater sofa  
divano 2 posti con schienale alto  
canapé 2 places à dossier haut

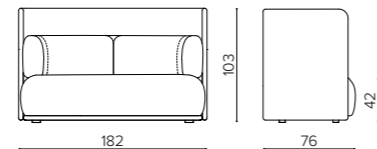

# m 10,7    ☆ mq 20    📦 kg 50    ⚙ mc 1,3

**SH 10CL/R**  
armchair with storage space  
poltrona con vano contenitore  
fauteuil avec espace de rangement

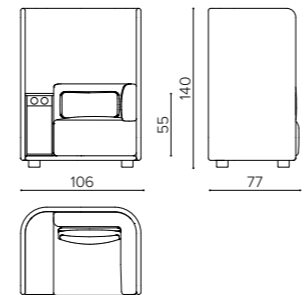

# m 7    ☆ mq 14    ⚙ mc 1,14

**SH PS02**

Power socket + 2 USB(A+A)  
Presa di alimentazione + 2 USB(A+A)  
Prises de courant + 2 USB(A+A)

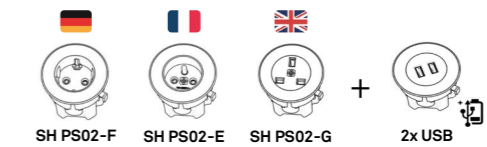

other socket types are available on request  
altre tipologie di prese sono disponibili su richiesta  
autres types de prises de courant sont disponibles sur demande

# UPHOLSTERY CATEGORIES

CATEGORIE RIVESTIMENTI - CATÉGORIES DE TISSUS D'AMEUBLEMENT

S	<b>camira</b>	GRAVITY	76% Polyester, 24% Recycled Polyester, non metallic dyestuffs 76% Poliestere, 24% Poliestere riciclato, coloranti non metallici 76% Polyester, 24% Polyester recyclé, colorants non métalliques
	<b>camira</b>	ERA	100% Polyester 100% Poliestere - 100% Polyester
	FIDIVI	LASER N	100% Polyester Trevira CS 100% Poliestere Trevira CS - 100% Polyester Trevira CS
	FIDIVI	ONE	100% Recycled polyester 100% Poliestere riciclato - 100% Polyester recyclé
T	FIDIVI	MAYA	100% Polyester Trevira CS 100% Poliestere Trevira CS - 100% Polyester Trevira CS
	FIDIVI	SEALIFE	100% Recycled Polyester 100% Poliestere riciclato - 100% Polyester recyclé
	FIDIVI	CORTE	100% Polyester Trevira CS 100% Poliestere Trevira CS - 100% Polyester Trevira CS
	<b>SPRADLING®</b>	VALENCIA	Vinyl / Urethane Topcoat Finitura in vinile / uretano - Revêtement de finition vinyle / uréthane
	<b>camira</b>	MAIN LINE FLAX	70% Virgin Wool, 30% Flax 70% Lana Vergine, 30% Lino - 70% Laine vierge, 30% Lin
	<b>camira</b>	MAIN LINE TWIST	75% Virgin Wool, 25% Flax 75% Lana Vergine, 25% Lino - 75% Laine vierge, 25% Lin
M	FIDIVI	LASER J & J FLASH	100% Polyester Trevira CS 100% Poliestere Trevira CS - 100% Polyester Trevira CS
	<b>kvadrat</b>	FIELD 2	100% Polyester Trevira CS 100% Poliestere Trevira CS - 100% Polyester Trevira CS
	<b>Gabriel</b>	FOCUS	100% New Zealand wool 100% lana della Nuova Zelanda - 100% laine de Nouvelle-Zélande
	<b>Gabriel</b>	FOCUS MELANGE	100% New Zealand wool 100% lana della Nuova Zelanda - 100% laine de Nouvelle-Zélande
	<b>Gabriel</b>	GRAIN	92% Post-consumer recycled polyester, 8% Polyester 92% Poliestere riciclato, 8% Poliestere 92% Polyester recyclé, 8% Polyester
F	<b>camira</b>	SYNERGY	95% Virgin Wool, 5% Polyamide 95% Lana Vergine, 5% Poliammide - 95% Laine vierge, 5% Polyamide
	<b>mariosirtori</b>	RICCIOLONE	56% Acrylic, 15% Polyester, 12% Viscose, 11% Cotton, 6% Flax 56% Acrilico, 15% Poliestere, 12% Viscosa, 11% Cotone, 6% Lino 56% Acrylique, 15% Poliestère, 12% Viscose, 11% Coton, 6% Line
	<b>Gabriel</b>	FOCUS ROYAL	100% New Zealand wool 100% Lana della Nuova Zelanda - 100% Laine de Nouvelle-Zélande
	<b>kvadrat</b>	REMIX 3	90% New wool (worsted), 10% Nylon 90% Lana vergine (pettinata), 10% Nylon - 90% Laine vierge (peignée), 10% Nylon
	<b>FLUKSO</b>	GORGEUS	50% PES FR - 50% TREVIRA® CS 50% PES FR - 50% TREVIRA® CS - 50% PES FR - 50% TREVIRA® CS
<b>mariosirtori</b>	MONTREAL	65% Wool, 24% Cotton, 6% Other Fibers, 5% Polyester 65% Lana, 24% Cotone, 6% Altre fibre, 5% Poliestere 65% Laine, 24% Coton, 6% Autres fibres, 5% Polyester	
L	<b>kvadrat</b>	TONUS 4	90% New wool, 10% Helanca 90% Pura lana vergine, 10% Helanca - 90% Pure laine vierge, 10% Helanca
	<b>camira</b>	CRAGGAN FLAX	85% Wool, 10% Flax, 5% Polyamide 85% Lana, 10% Lino, 5% Poliammide - 85% Laine, 10% Line, 5% Polyamide
P	<b>DANI</b>	PANAMA GENUINE LEATHER	Chrome tanned european bovine raw hides Pelle bovina europea ai sali di cromo - Cuir de bovin européenne avec sels de chrome
PX	<b>elmo</b>	BALTIQUE FULL GRAIN LEATHER	European bovine leather Pelle bovina europea - Cuir de bovin européen

# OUTDOOR UPHOLSTERY CATEGORIES

CATEGORIE RIVESTIMENTI OUTDOOR - CATÉGORIES DE TISSUS D'AMEUBLEMENT OUTDOOR

M	<b>SPRADLING®</b>	MAGLIA	Vinyl / Urethane Topcoat Finitura in vinile / uretano - Revêtement de finition vinyle / uréthane
	<b>RUBELLI</b>	FIFTYSHADES	100% PL flame retardant 100% PL ignifugo - 100% PL ignifuge
L	<b>RUBELLI</b>	DIECIELODE	100% PL flame retardant 100% PL ignifugo - 100% PL ignifuge
	<b>RUBELLI</b>	FABTHIRTY	100% PL flame retardant 100% PL ignifugo - 100% PL ignifuge

**Inspire. Create. Deliver.**